



User Guide DT-210/230 Thermal Receipt Printer



Important Safety Instructions (English)

Read the following instructions thoroughly before starting up your printer.

- Never carry out maintenance or repair work yourself. Always contact a qualified service technician.
- Keep this user guide in a place which is easily accessible at all times.
- Place the printer on a solid and even base so that it cannot fall.
- Never place the printer in the vicinity of inflammable gas or explosive substances.
- Ensure the printer is connected to a socket with the correct voltage.
- Always disconnect the printer from the power before opening the device to perform maintenance work or remedy errors.
- Do not expose the printer to high temperatures, direct sunlight or dust.
- Keep all liquids away from the printer.
- Protect the printer from shock, impact and vibration.
- Make sure that both the printer and the computer are switched off before connecting the data cable.
- The print head will become very hot during printing; avoid contact with the print head after printing has finished.
- Do not perform any operation or action in any way other than those provided in this manual. When in doubt, contact your dealer or your customer support.

Wichtige Sicherheitshinweise (German)

Lesen Sie bitte diese Sicherheitshinweise durch, bevor Sie den Drucker in Betrieb nehmen.

- Führen Sie Wartungsarbeiten und Reparaturen keinesfalls selbst aus, sondern verständigen Sie immer einen qualifizierten Servicetechniker.
- Bewahren Sie diese Dokumentation an einem jederzeit zugänglichen Ort auf.
- Den Drucker auf stabilem und ebenem Untergrund so aufstellen, dass er nicht zu Boden fallen kann.
- Stellen Sie den Drucker keinesfalls in der Nähe von leicht entzündlichen Gasen oder explosiven Stoffen auf.
- Den Drucker nur an eine Steckdose mit der richtigen Spannung anschließen.
- Wenn Sie den Drucker vom Netz trennen wollen, den Drucker ausschalten und immer den Netzstecker an der Steckdose ziehen.
- Den Drucker weder hohen Temperaturen noch direktem Sonnenlicht und Staub aussetzen.
- Keine Flüssigkeiten mit dem Drucker in Berührung bringen.
- Den Drucker keinen Erschütterungen, Stößen oder Vibrationen aussetzen.
- Sicherstellen, dass der Drucker und der Computer ausgeschaltet sind, bevor das Datenkabel angeschlossen wird.
- Der Druckkopf wird während des Druckens heiß. Vor dem Berühren deshalb einige Zeit abkühlen lassen.
- Weichen Sie bei der Bedienung des Druckers nicht von den Anweisungen in der Dokumentation ab. Bei Unklarheiten wenden Sie sich bitte an Ihren Händler oder Ihren Kundendienst.

Consignes importantes de sécurité (French)

Lire attentivement les instructions suivantes avant de mettre l'imprimante en service.

- Ne jamais effectuer soi-même les travaux d'entretien et de réparations. Contacter toujours un dépanneur qualifié.
- Placer l'imprimante sur un support stable de façon à ce qu'elle ne puisse pas tomber.
- Ne jamais placer l'imprimante à proximité de sources de gaz aisément inflammables ou de substances explosives.
- Ne connecter l'imprimante à une prise que lorsque la tension est correcte.
- Pour déconnecter l'imprimante de l'alimentation principale, mettre l'imprimante hors tension et toujours débrancher le connecteur secteur de la prise murale.
- Ne pas exposer l'imprimante à des températures élevées, à la lumière directe du soleil ou à la poussière.
- Ne pas mettre l'imprimante en contact avec des liquides.
- Ne pas exposer l'imprimante à des chocs, impacts ou vibrations.
- S'assurer que l'imprimante et l'ordinateur sont hors tension avant de connecter le câble de données.
- La tête d'impression est brûlante pendant l'impression. C'est pourquoi laissez-la refroidir quelques instants avant d'y toucher.
- N'exécutez aucune opération ni action d'une autre manière que celle indiquée dans ce manuel. En cas de doute, veuillez contacter votre distributeur ou service après-vente.

Indicazioni di sicurezza importanti (Italian)

Prima di mettere in funzione la stampante, leggere attentamente le seguenti indicazioni.

- Non eseguire mai da sé gli interventi di manutenzione e riparazione, ma rivolgersi sempre a un tecnico di assistenza qualificato.
- Conservare le presenti istruzioni per l'uso in un luogo sempre accessibile.
- Collocare la stampante su una superficie stabile, per evitare che cada a terra.
- Non collocare la stampante in prossimità di gas facilmente infiammabili o di sostanze esplosive.
- Collegare la stampante a una presa di corrente con tensione adeguata.
- Per scollegare la stampante dalla rete di alimentazione, spegnere la stampante e disinserire sempre il connettore di rete dalla presa.
- Non esporre la stampante ad elevate temperature né alla luce solare diretta e alla polvere.
- Evitare il contatto della stampante con liquidi.
- Non esporre la stampante a colpi, scosse o vibrazioni.
- Verificare che la stampante e il computer siano spenti prima di collegare il cavo di trasmissione dati.
- Durante la stampa, la testina si surriscalda notevolmente. Prima di toccarla, se necessario opportuno quindi lasciarla raffreddare qualche istante.
- Non eseguire alcuna operazione o azione se non nella maniera descritta nel presente manuale. In caso di dubbio, contattare il rivenditore o dalla società incaricata dell'assistenza.

Instrucciones de seguridad importantes (Spanish)

Lea las siguientes instrucciones con esmero antes de poner la impresora en servicio.

- Nunca lleve a cabo trabajos de mantenimiento o reparación Ud. mismo, sino consulte a un técnico de servicio calificado.
- Guarde las presentes instrucciones de servicio en un lugar de fácil acceso en cualquier momento.
- Ponga la impresora sobre un base estable de manera que no pueda caer al suelo.
- Nunca coloque la impresora en la vecindad de gases de fácil inflamabilidad o sustancias explosivas.
- Asegure conectar la impresora sólo a un enchufe con un voltaje correcto.
- Cuando quiera desconectar la impresora de la red, apague la impresora y siempre tire la clavija de alimentación del enchufe.
- No exponga la impresora a temperaturas altas, a la luz solar directa y al polvo.
- No ponga la impresora en contacto con fluidos.
- Nunca exponga la impresora a sacudidas, choques o vibraciones.
- Asegúrese de que la impresora y el ordenador estén apagados antes de conectar el cable de datos.
- La cabeza de impresión se pone muy caliente durante la impresión. Por lo tanto, deje enfriarlo algún tiempo antes de tocarla.
- No permita que se realice cualquier operación o acción de una forma diferente a lo que se señala en el manual. En caso de duda, póngase en contacto con su comerciante o con su servicio post-venta.

Правила по технике безопасности. (Russian)

Прочитайте, пожалуйста, инструкцию по технике безопасности перед включением в работу принтера.

- Не выполняйте технические работы и ремонт техники самостоятельно, но сообщайте о неисправностях квалифицированным сервисным техникам.
- Данная инструкция должна быть всегда доступна каждому пользователю.
- Установите принтер на ровном и стабильном месте так, чтобы он не смог упасть на пол.
- Ни в коем случае не ставьте принтер вблизи легко воспламеняющихся газов и взрывчатых веществ.
- Включайте принтер в розетку только с соответствующим напряжением.
- Если Вы хотите отключить принтер от напряжения, сначала выключите принтер сам и затем выньте штекер из розетки.
- Берегите принтер от нагревания, от попадания на него прямых солнечных лучей и пыли.
- Не допускайте попадания жидкости на принтер.
- Нельзя подвергать принтер тряске, ударам и вибрации.
- Убедитесь, что принтер и компьютер выключены, только после этого соедините принтер с компьютером.
- Печатающая головка нагревается во время работы принтера. Поэтому подождите какое-то время, прежде чем дотронуться до нее.
- Пользуйтесь принтером так, как это написано в документации. Если у Вас возникают неясности, обращайтесь с вопросами к Вашим продавцам или в сервисный центр.

Instruções Importantes sobre Segurança (Portuguese)

Leia as instruções de segurança antes de usar a impressora.

- Consulte sempre um técnico qualificado para executar uma reparação .
- Coloque a impressora sobre uma base sólida e nivelada, para que ela não sofra quedas.
- Jamais instale a impressora nas proximidades de lugares onde haja gás inflamável ou substâncias explosivas.
- Assegure-se de conectar a impressora à tomada elétrica com a voltagem apropriada.
- Quando desligar a impressora da rede, desligue sempre a impressora e retire o cabo da tomada.
- Não exponha a impressora a temperaturas altas ou luz solar direta.
- Não aproxime substâncias líquidas da impressora.
- Proteja a impressora de choques, impactos e vibrações.
- Desligue a impressora e o computador antes de conectar o cabo da rede.
- A cabeça da impressora pode ficar muito quente . Portanto, espere algum tempo antes de tocá-la.
- Não faça nenhuma operação ou ação além das recomendadas neste manual. Em caso de dúvida, contate seu revendedor ou companhia de serviço.

Önemli Güvenlik Talimatları (Turkish)

Lütfen, yazıcıyı işleme geçirmeden önce bu güvenlik talimatlarını bütünüyle dikkatle okuyun.

- Bakım ve tamir çalışmalarını kesinlikle ve hiçbir surette kendi başınıza yapmayın; her zaman kalifiye bir uzman servis-teknisyenine haber verin.
- Yazıcıyı, üzerinden yere düşmesi mümkün olmayacak sabit ve düz bir zemine yerleştirin.
- Yazıcıyı kesinlikle ve hiçbir surette kolayca yanabilecek gaz veya patlayıcı maddeler içeren nesnelere yakınına koymayın.
- Yazıcı akım kablosunu sadece doğru gerilime sahip bir prize takın.
- Yazıcıyı şebeke ağından ayırmak istediğinizde, yazıcıyı kapatın ve ağ-fişini her zaman prizden çıkartın.
- Yazıcıyı ne yüksek ısı ne de doğrudan güneş ışığına ve toza mâruz kalan mekânlarda bulundurun.
- Yazıcı hiçbir sıvı maddeyle temasta olmamalıdır.
- Yazıcı hiçbir sarsıntıya, darbeye veya titreşime mâruz kalmamalıdır.
- Veri kablosu bağlanmadan önce hem yazıcının hem de bilgisayarın kapalı olduklarından emin olmalısınız.
- Yazıcının başı basma esnasında yüksek ısıya ulaşıyor. Bu yüzden lütfen dokunmadan önce kısa süre soğumasını bekleyin.
- Yazıcının işletimi ve kullanımında bu dokümantasyondaki talimatların hiç dışına çıkmayın. Sorunlu görünen hususlarda lütfen imâlatçınıza veya müşteri hizmetleri servisimize başvurun.

TRADEMARK ACKNOWLEDGEMENTS

“IBM” is a trademark of International Business Machines Corporation.

“EPSON” is a trademark of Epson America Incorporated.

“DEC” is a trademark of Digital Equipment Corporation.

“Centronics” is a trademark of Centronics Data Computer Corporation.

“DOS” is a trademark of Microsoft Corporation.

“SAP” is a trademark of SAP AG.

“Windows”, “Windows 7”, “Windows 8”, “Windows 95”, “Windows 98”, “Windows NT”, “Windows 2000”, “Windows 2003/2008/2013 Server”, “Windows XP” and “Windows Vista” are trademarks of Microsoft Corporation.

All other product names and company names appearing in this manual are the registered trademarks or trademarks of the individual companies.

TABLE OF CONTENTS

1 PRINTER INSTALLATION GUIDE	1
1.1 Unpacking the printer	1
1.2 Placing the printer.....	2
1.3 Printer components	3
1.4 Connecting the interfaces	4
1.5 Connecting power	6
1.6 Adjusting the near end sensor	7
1.7 Installing Roll Paper.....	8
1.7.1 Installing 80mm Roll Paper	8
1.7.2 Installing 58mm Roll Paper	9
1.8 Installing the accessory and optional kits	10
1.9 Installing the printer driver	11
2 CONTROL PANEL OPERATION	18
3 SETTING DIP SWITCHES	19
4 TROUBLESHOOTING	22
4.1 Processing LED and printing error.....	22
4.2 Removing jammed paper.....	23
4.3 Cleaning thermal print head	24
5 SPECIFICATIONS	25
5.1 Printer specification	25
5.2 Interfaces	27
5.2.1 USB interface.....	27
5.2.2 Cash Drawer interface.....	27
5.2.3 Serial interface	28
5.2.4 Parallel interface	28
5.2.5 Ethernet interface	30
5.2.6 Wi-Fi interface	30
5.3 Power adapter.....	30
5.4 Paper specification.....	31
6 CHARACTER CODE PAGES	33
7 PRINTING CONTROL COMMAND SETS	48
FCC STATEMENT	52
DASCOM REPRESENTATIVES	53

1 Printer Installation Guide

1.1 Unpacking the printer

Open the packaging, lift the printer out of the cardboard box and remove the remaining packaging material. Check the printer for any visible transport damage and missing items. If you find any transport damage or any accessories are missing, please contact your dealer for assistance.

- i** Please keep the packaging material for future transportation.
The shipping list varies with different customized order requirements.

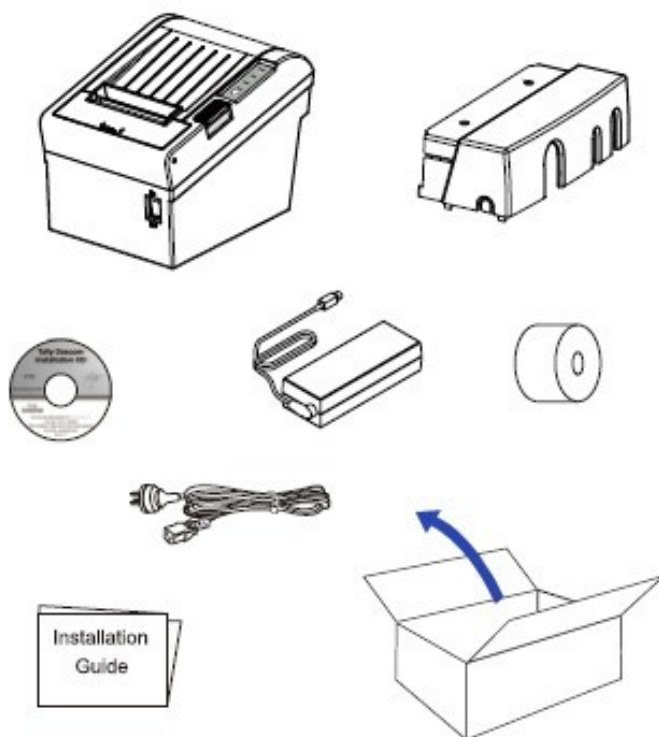

1.2 Placing the printer

Place the printer on a solid, flat, stable surface; ensure that the printer is positioned in such a way that it cannot move, and that there is easy access to the control panel and roll paper holder. Also ensure that there is enough space for sufficient ventilation and for the printed output.

When selecting the printer location, observe the following additional instructions:

- Never place the printer near to any flammable gas or explosive substances.
- Do not expose the printer to direct sunlight. If you cannot avoid placing the printer near a window, protect it from the sunlight with a curtain.
- When connecting a computer to the printer, make sure the maximum recommended cable length is not exceeded.
- Ensure sufficient distance between the printer and any heating devices or radiators.
- Avoid exposing the printer to extreme temperature or air humidity fluctuations. Avoid exposure to dusty environments.
- It is recommended the printer is installed in a position which reduces noise exposure to the work place during printing.

1.3 Printer components

Printer components and functions are shown as below:

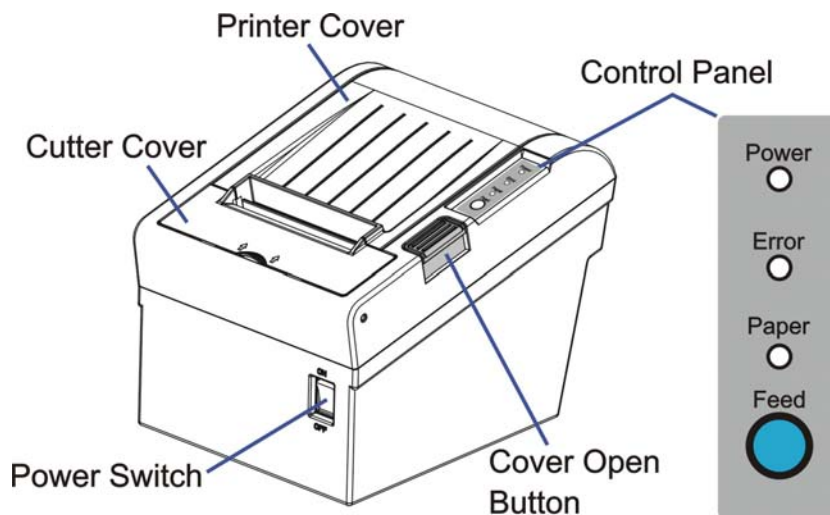

Component	Function
Printer Cover	Open the cover when loading roll paper.
Control Panel	Shows printer status.
Power Switch	To power printer ON or OFF.
Cutter Cover	To protect the auto-cutter and to clear paper jam at cutter.
Cover Open Button	Press down to open the Printer Cover

1.4 Connecting the interfaces

The USB, Cash Drawer, Serial/Parallel/Ethernet/Wi-Fi interface ports are located at the rear of the printer. Choose the interface which suits your system.

i Make sure the printer and the computer are switched off before connecting or disconnecting the interface cable to prevent electrical damage to the interface ports.

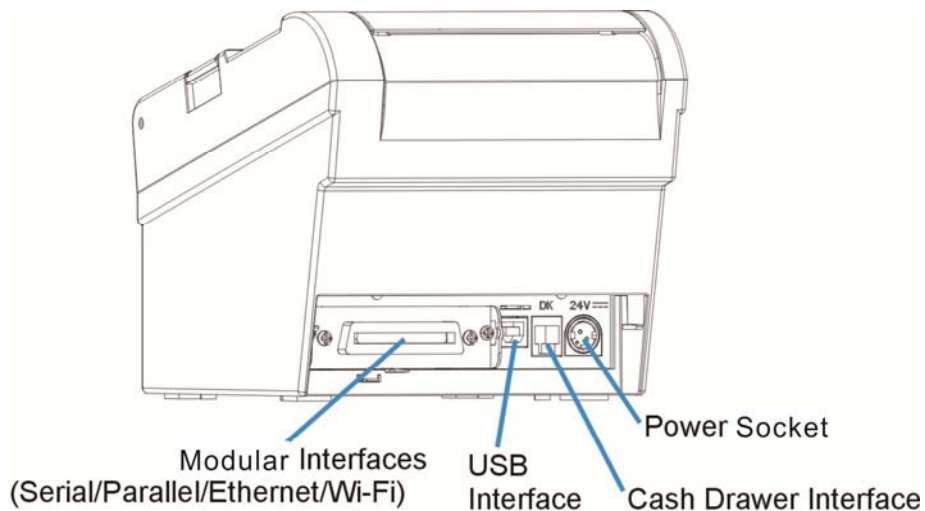

Component	Function
Power Socket	Connects power cord to the printer.
Cash Drawer Interface	Connects Cash Drawer interface cable from the cash drawer.
USB Interface	Connects USB interface cable from the host.
Modular Interface Board	Connects optional interface (Serial I/F, Parallel I/F, Ethernet I/F or Wi-Fi I/F) from the host.

■ Connecting USB interface

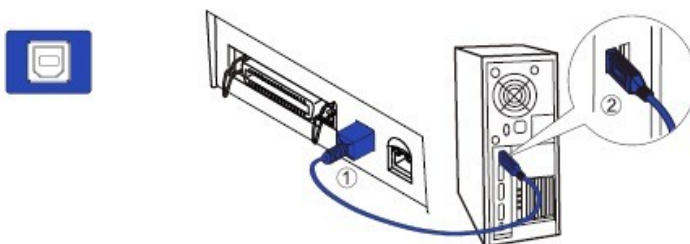

■ Connecting Cash Drawer interface

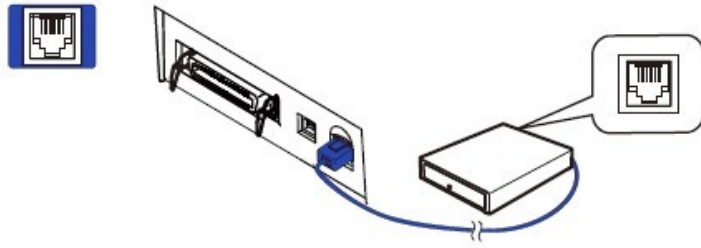

■ Connecting Parallel interface (Modular, option)

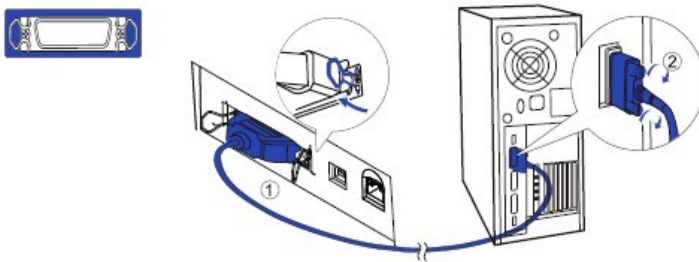

■ Connecting Serial interface (Modular, option)

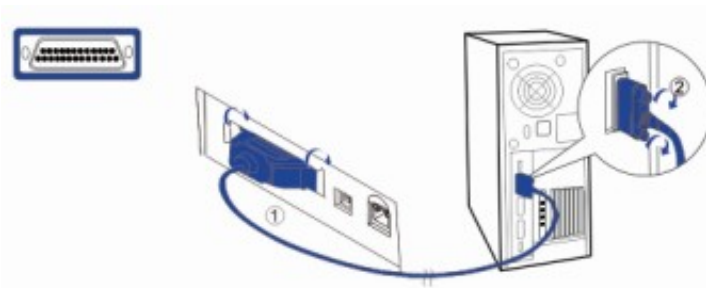

■ Connecting Ethernet interface (Modular, option)

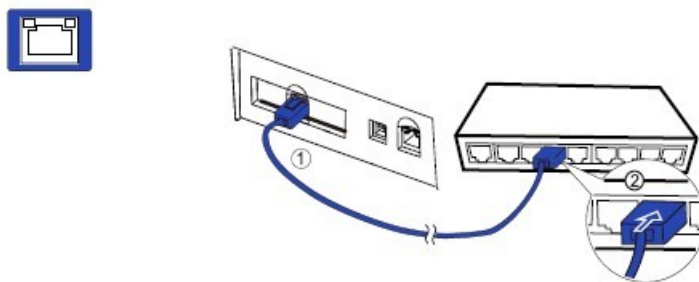

■ Connecting Wlan interface (Wi-Fi, Modular, option)

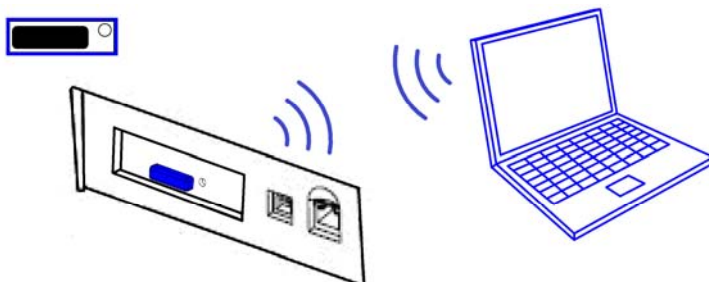

1.5 Connecting power

i Checking the voltage of the power adapter

Before you connect the power adapter to the power socket check if the voltage is correct. If you connect the power adapter to power with incorrect voltage this may result in electrical damage to adapter and printer.

1. Make sure the printer and the computer are powered off ①.
2. Connect the power cord to the power adapter ②, and connect the power adapter to the power supply interface at the rear of the printer ③. Ensure the power cord is securely connected. Connect the power cord plug to a mains socket on the wall ④.

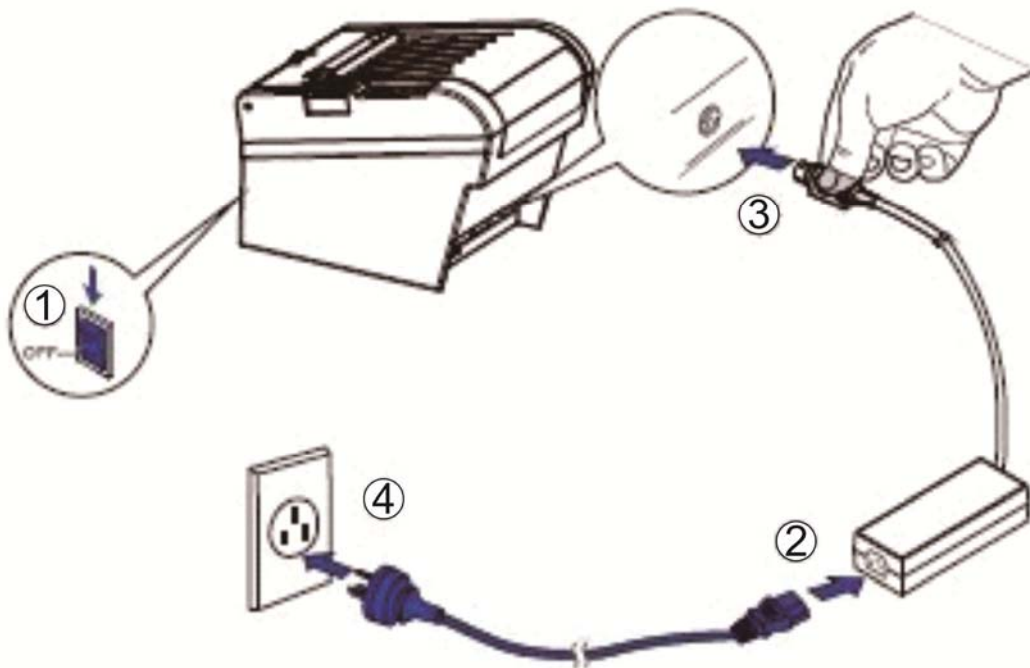

■ Power on and power off

1. Press the power switch to the “I” position to turn on the printer.
Upon power-on, the Power LED indicator light up.
2. Press the power switch to the “O” position to turn off the printer.

1.6 Adjusting paper near end sensor

Open the printer cover. You will see a black lever inside as shown below.

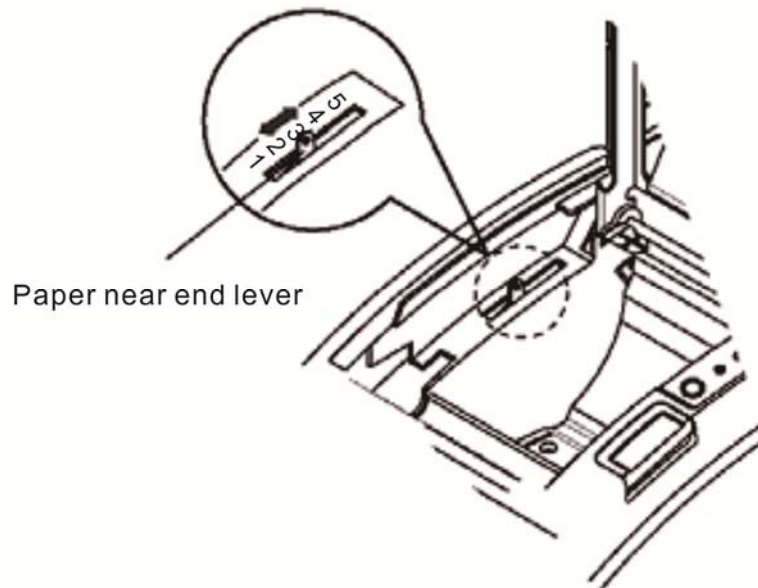

The printer has a paper near-end sensor that provides notice that the paper roll is nearly exhausted. When the paper is running low, the paper LED is lit red.

If you find that there is not enough paper remaining on the roll when the near-end sensor is triggered, you can change the near-end sensor setting.

Adjustments:

The paper near end lever is continuously adjustable from "1" to "6".

1. Minimum paper remains until paper end. (Paper roll diameter about 26mm)
2. Paper remains until paper end. (Paper roll diameter about 27mm)
3. Paper remains until paper end. (Paper roll diameter about 28mm)
4. Paper remains until paper end. (Paper roll diameter about 30mm)
5. Paper remains until paper end. (Paper roll diameter about 32mm)
6. Maximum paper remains until paper end. (Paper roll diameter about 33mm)

1.7 Installing Roll Paper

1.7.1 Installing 80mm Roll Paper

1. Press the cover open button to open the cover.



2. The correct installing direction of the roll paper.



3. Remove any used roll paper core, and load the new roll paper.

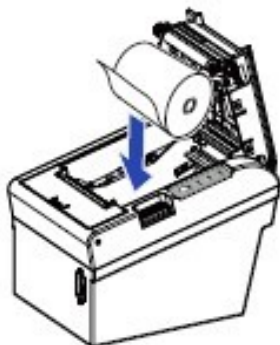

4. Pull out some paper over cutter cover as shown on the left picture below ①, then close the cover ② and tear off the paper as shown on the right picture below ③.

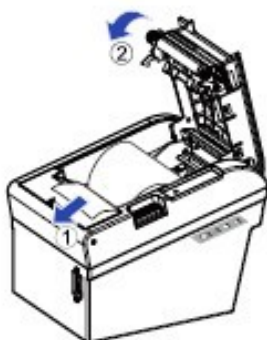

1.7.2 Installing 58mm Roll Paper

If you want to install 58mm roll paper, open the printer cover, you will see a roll paper guide on the right side of the paper holder.

STOP Please do not move the roll paper guide from right to left directly to avoid breaking the separator.

1. Hold the roll paper guide and carefully pull it out in the direction of arrow.
2. Move roll paper guide from right side to the specified position near the middle of paper holder, and carefully insert it into the specified position.
3. Then you can install the 58 roll paper as 80mm roll paper installation above.

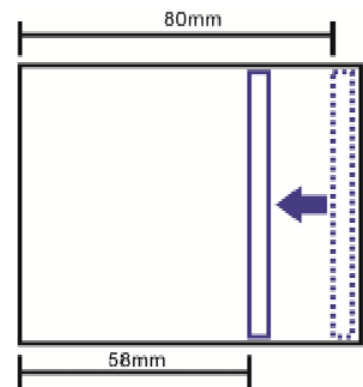
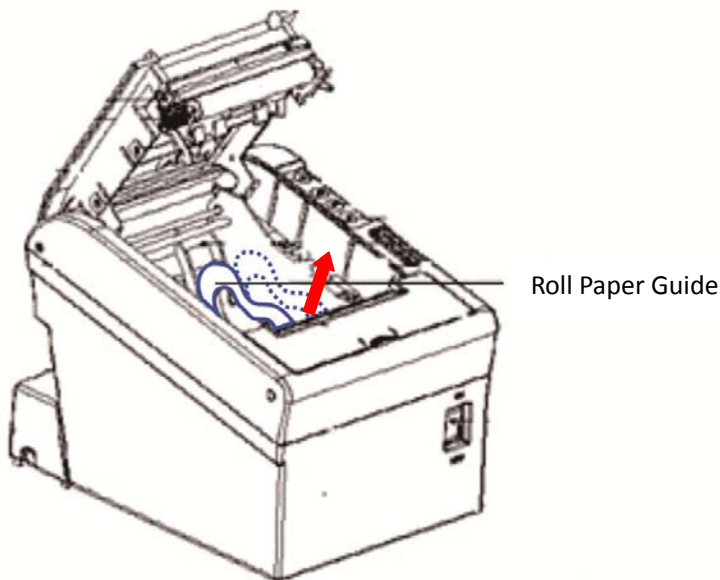

1.8 Installing the accessory and optional kits

■ Interface Cover

Adjust the relative positions between interface cover and printer as shown below, and push the interface cover as arrow shows below.



■ Splash Cover (Optional Kit)

Slip the fixed hooks on both sides of splash cover into the mounting hole on the printer, and close the splash cover.



■ Hanging Plate (Optional Kit)

1. Mount the hanging plate on the lower housing of the printer with screws ①;
2. Align the positioning holes of the hanging plate and plug into the fixed screws on the wall ②.

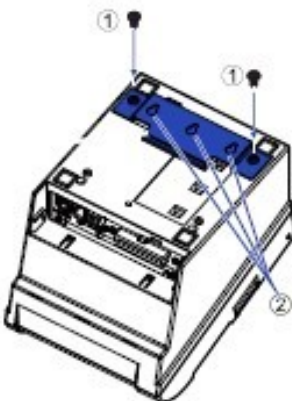

1.9 Installing the printer driver

Installing the Windows Driver (Compatible with Windows)

 **Switch off the printer before running the printer driver setup.**

Your printer CD-ROM comes with Windows drivers. Go to the Drivers folder and run the installer “DriverSetup.exe”.

1.10.1 Installation guide for USB, serial and parallel driver program

1. Double click the “DriverSetup”. You will see the screen as below. Choose “English” and then click “OK” to continue.

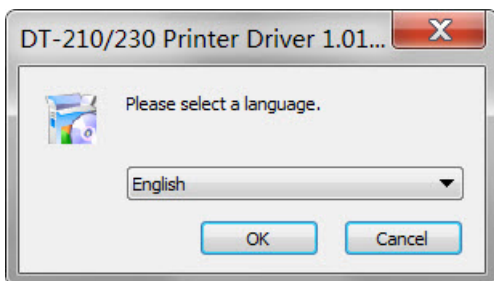

2. You might see the screen as below. Please click “Next” to continue.

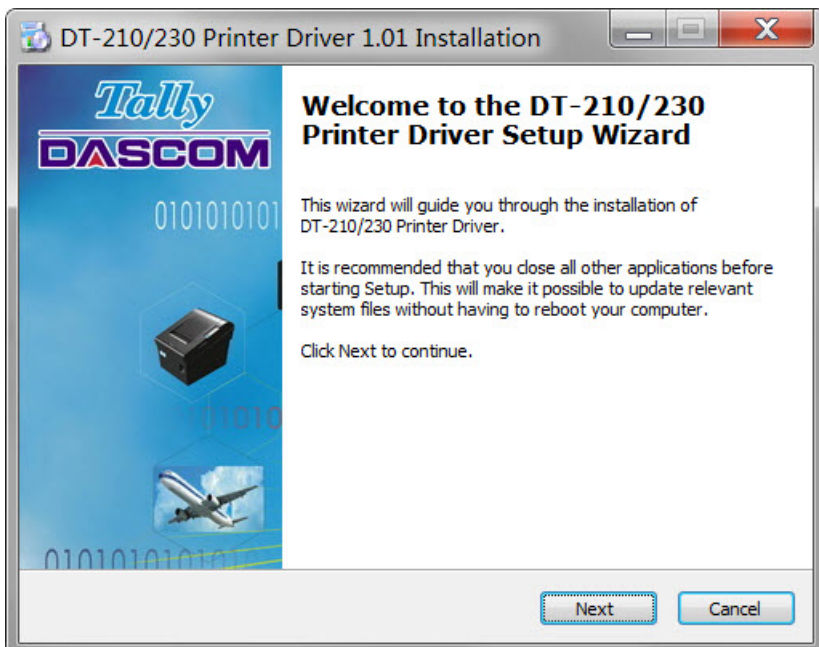

Tally Dascom DT-210/230

3. Choose the desired port to use, after selecting the “Port” option (USB001 for USB port, com1 for serial port and LPT1 for parallel port), click “Next” to continue.

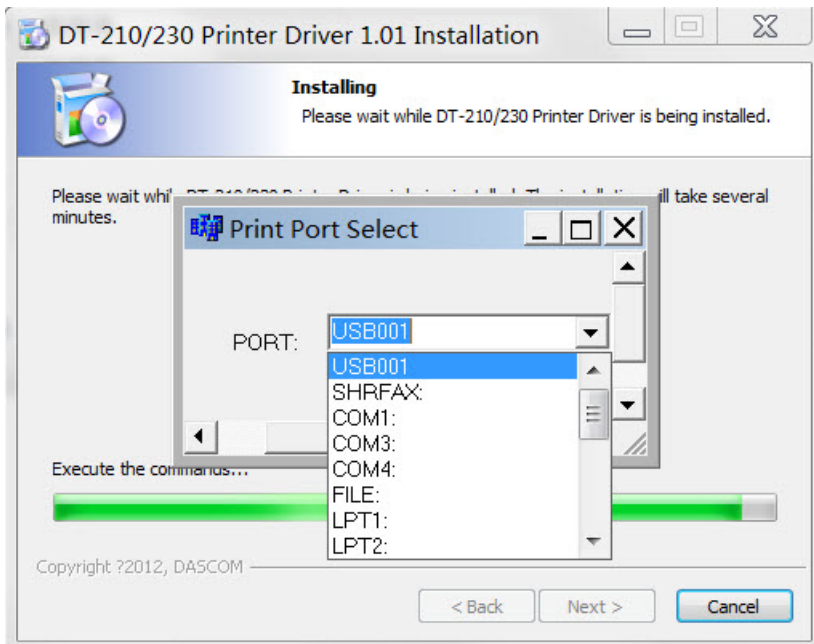

4. Click “Finish” to finish the installation process successfully.

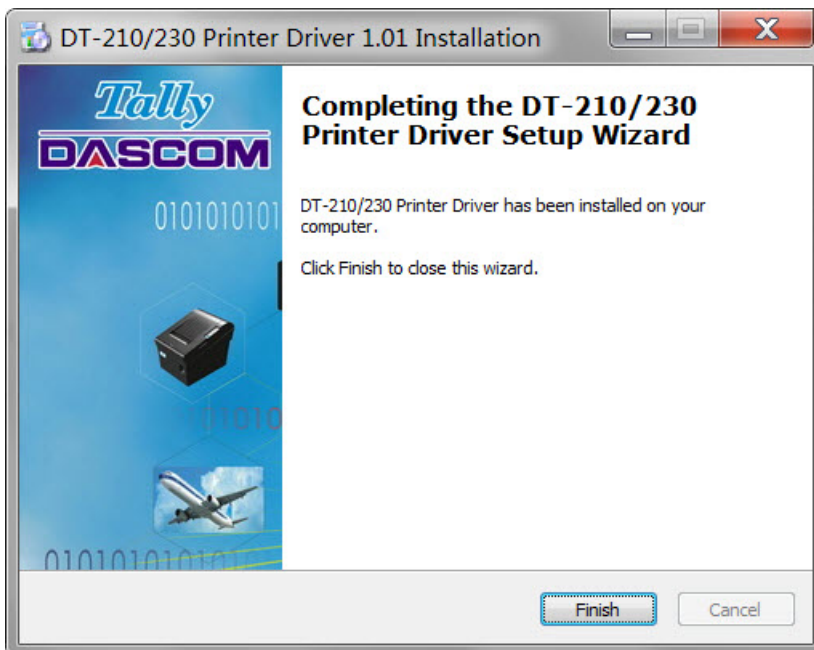

1.10.2 Installation guide for Ethernet and Wi-Fi driver program

1. Install the printer driver as USB installation.
2. Click “Start” → “Devices and Printers”, right click on the DT-230 Printer Driver, and then click “Printer Properties”.

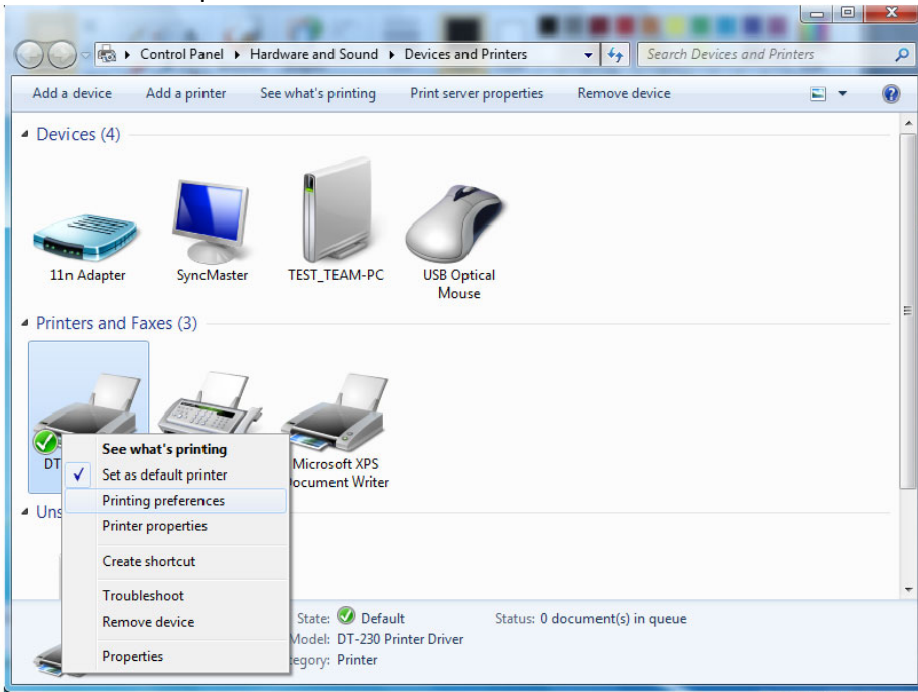

3. Then you will see the screen as below. Click “Ports” → “Add Port”.

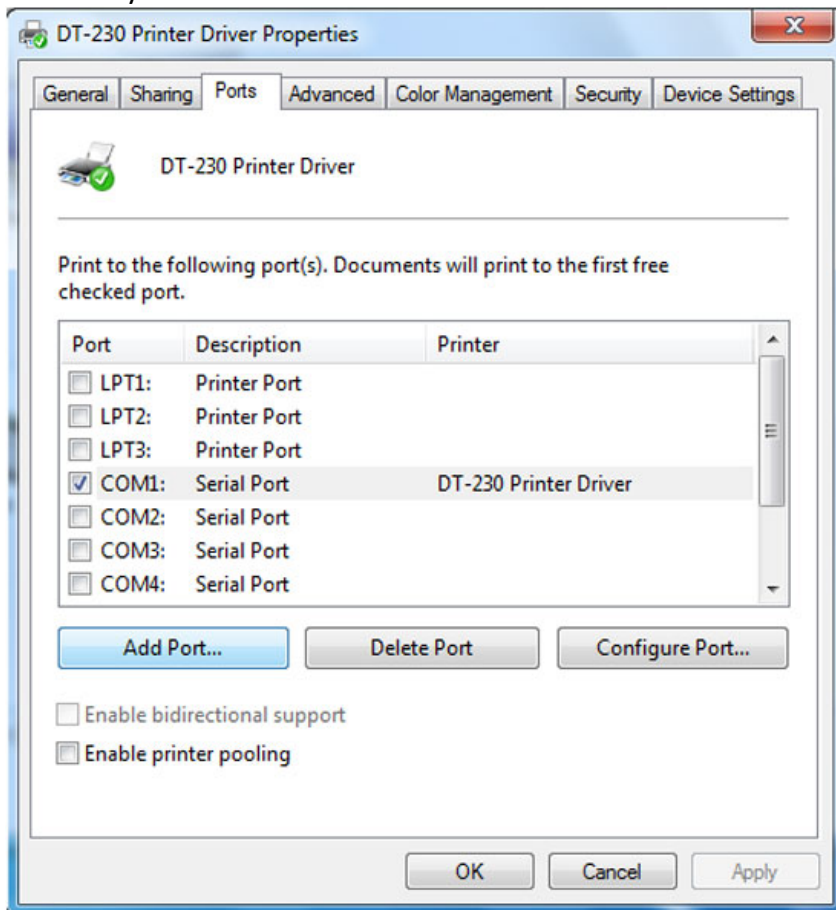

4. Select “Standard TCP/IP Port”, and click “New Port”.

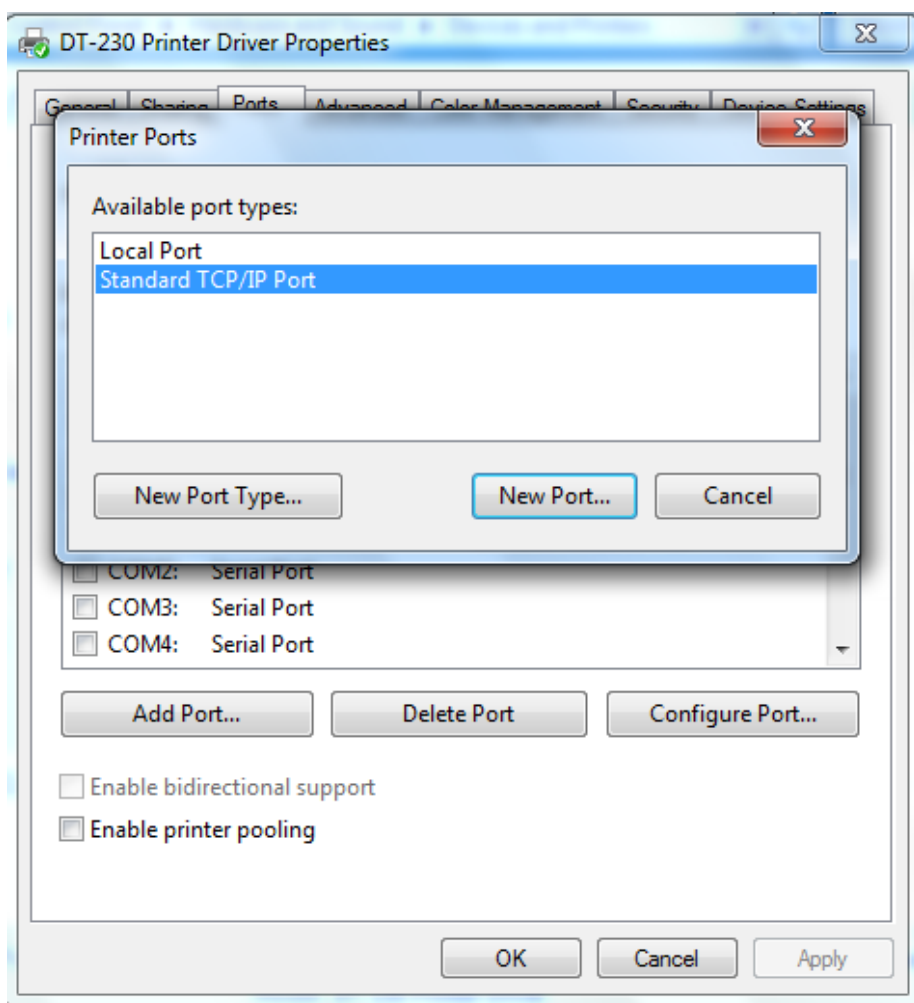

5. You will see the screen as below, click “Next” to continue.

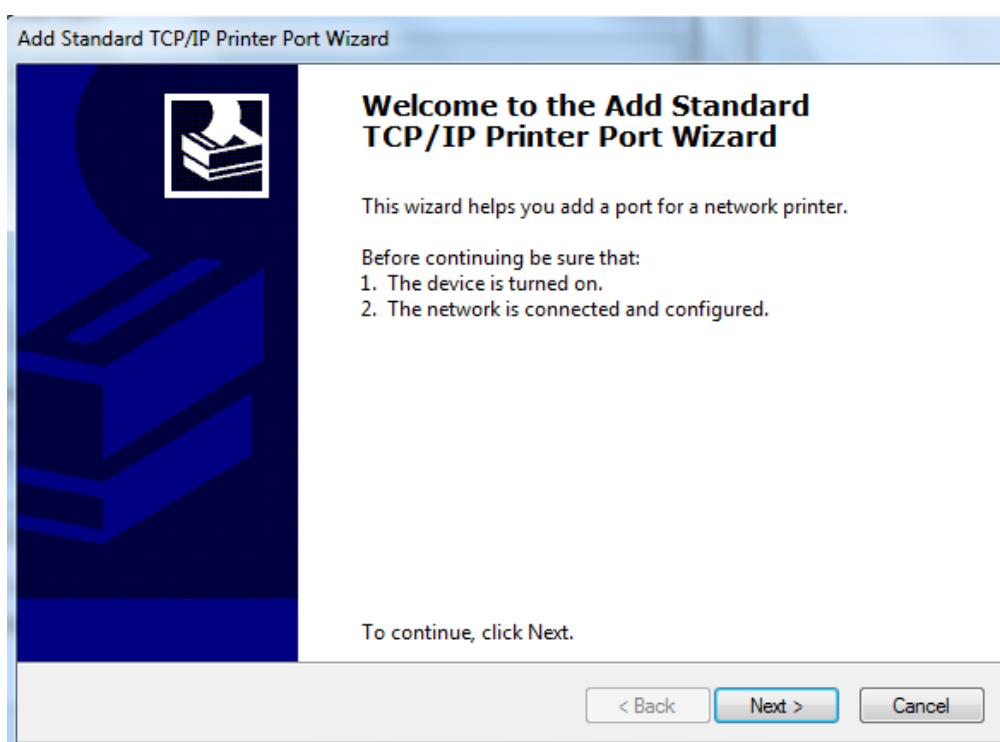

Tally Dascom DT-210/230

6. Complete the “Printer Name or IP Address” and “Port Name”.

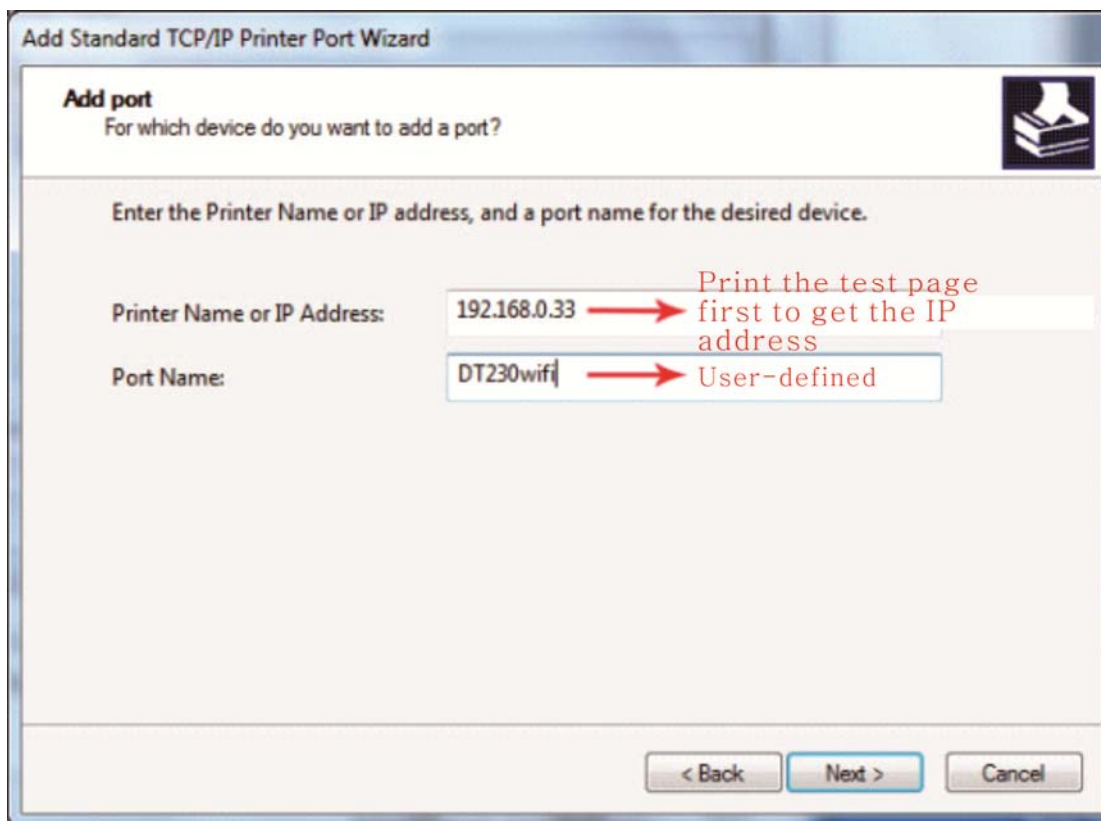

7. Click “Next” to access the screen as below.

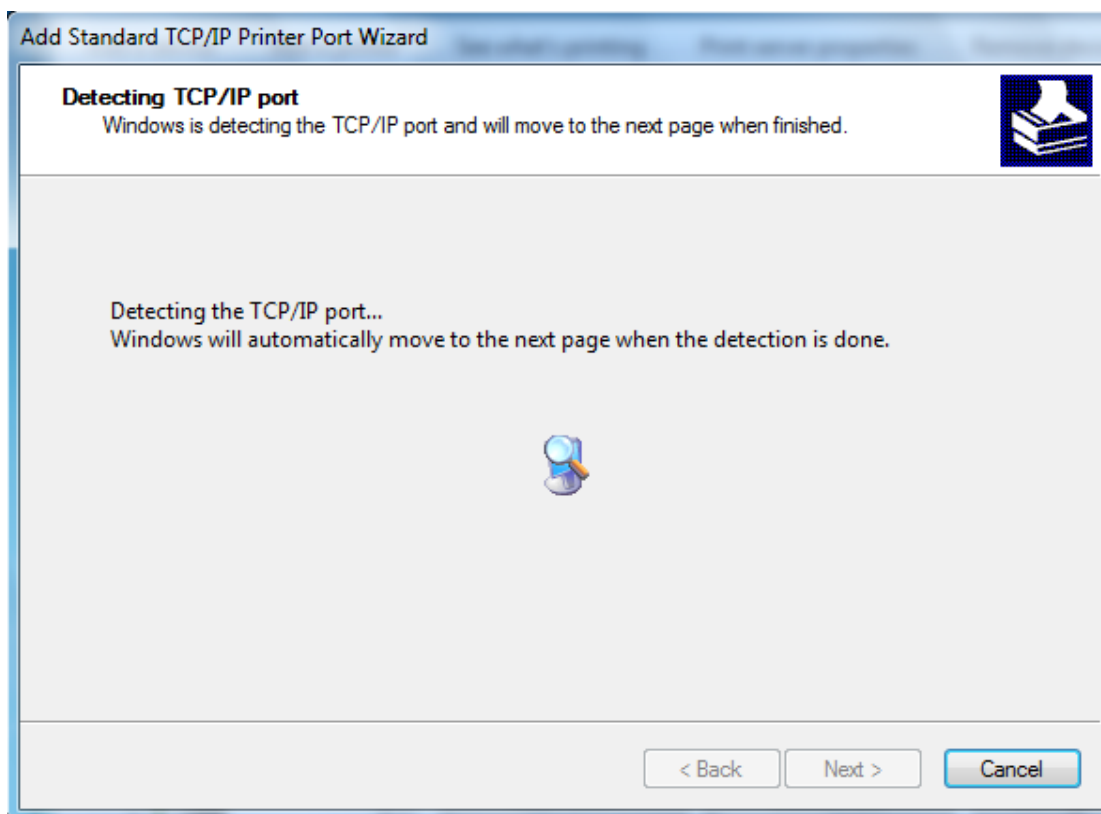

8. And then you will see the screen as below, click “Next” to continue.

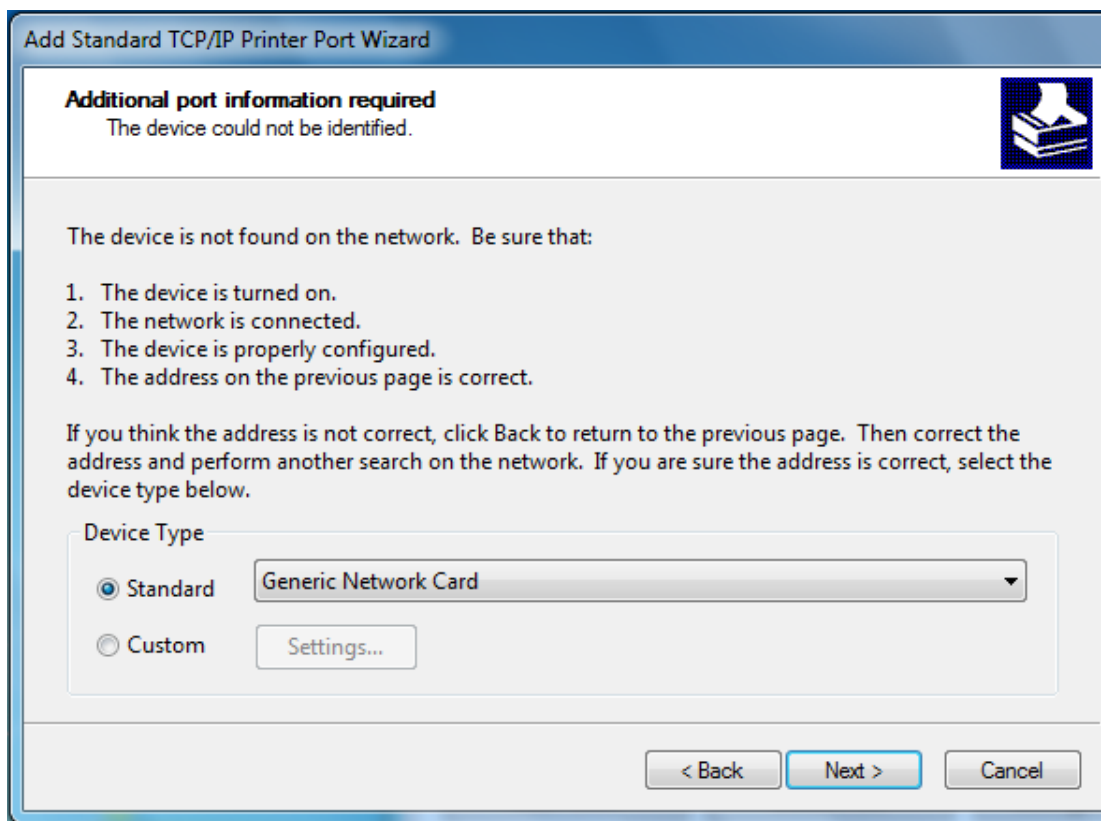

9. Click “Finish” to complete the printer driver installation.

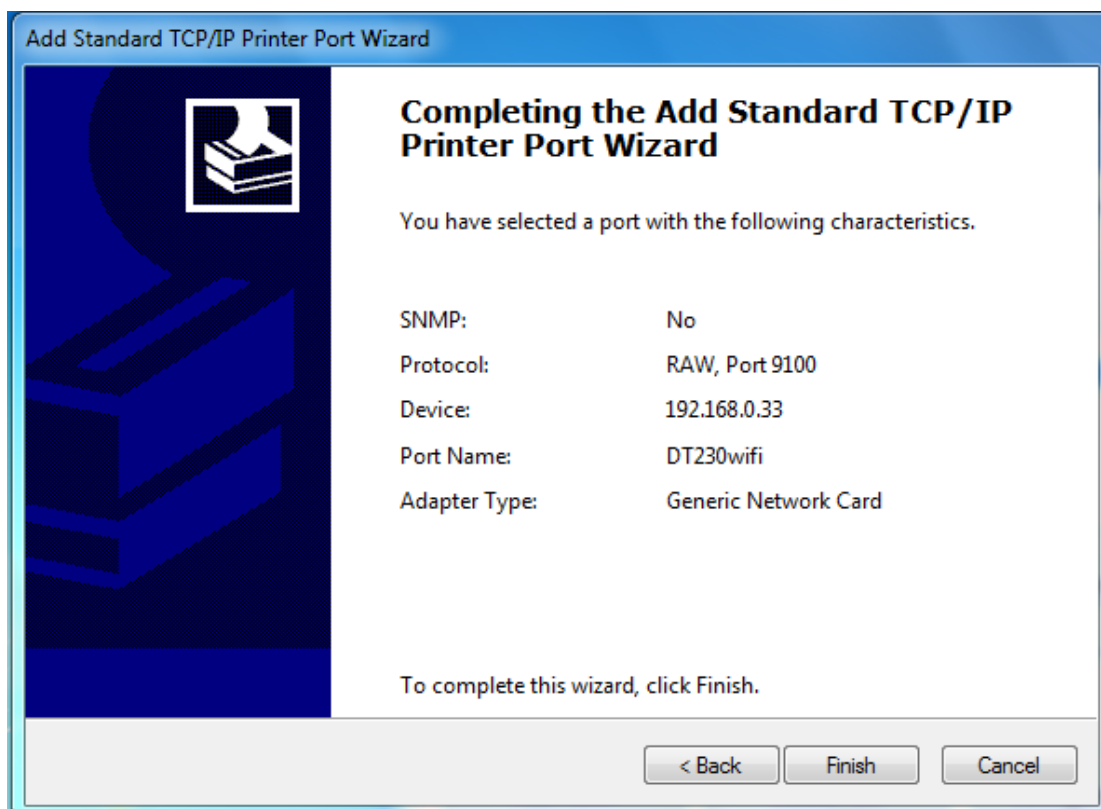

Tally Dascom DT-210/230

10. Click “Start” → “Devices and Printers”, right click on the DT-230 Printer Driver, and then click “Printer Properties”. Then click “Ports” → “Configure Port”, finish the setup parameter in the screen as below. Click “OK” to finish the setup.

Configure Standard TCP/IP Port Monitor

Port Settings

Port Name: DT230wifi

Printer Name or IP Address: 192.168.0.33

Protocol

Raw LPR

Raw Settings

Port Number: 9100

LPR Settings

Queue Name:

LPR Byte Counting Enabled

SNMP Status Enabled

Community Name: public

SNMP Device Index: 1

OK Cancel

2 Control Panel Operation

■ LED indicators and key

Power LED

Power LED turns on while printer is powered on.

Error LED

Error LED turns on means error occurs.

Paper LED

Paper LED turns on means paper near end or paper end.

Feed key

Press Feed key to feed paper.

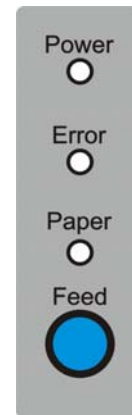

■ Self-test

Turn off the power after roll paper loaded, hold down the Feed key while printer is powering on, then the self-test page is printed out. "If you want to continue SELF-TEST printing, please press Feed key." would be printed out after the current printer status is printed, also Paper LED would be turned on; Press Feed key to continue the character printing. After a number of lines are printed, the printer indicates the end of the self-test by printing "*** completed ***".

■ Hexadecimal Dumping

Open the Printer Cover, load roll paper and turn the power on while holding down Feed key, and then close the Printer Cover, the printer would run Hexadecimal Dumping printing mode. Press Feed key for three times to exit Hexadecimal Dumping printing mode.

■ LED indicators

Description	POWER	ERROR	PAPER	BEEPER
Printer Cover is open	On	On	On	Short beep for twice and long beep for once
Roll paper is sufficient	On	Off	Off	No beep
Roll paper end	On	On	On	Short beep for three times
Roll paper near end	On	Off	On	No beep

3 Setting DIP Switches

You will see a metal plate on the bottom of the printer. Remove the metal plate with a screwdriver. You will find two DIP switches on the main control board as shown below.

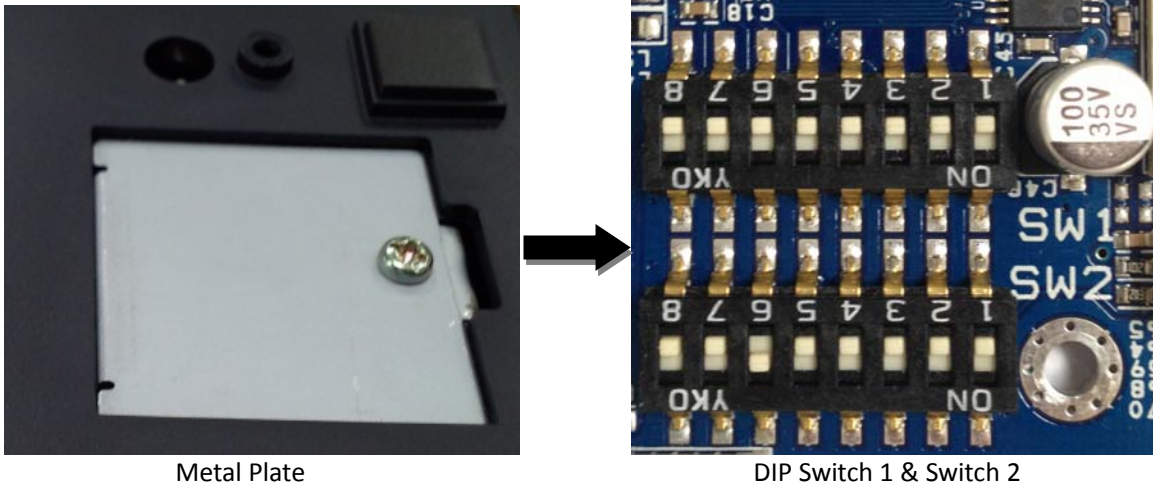

Metal Plate

DIP Switch 1 & Switch 2

There are two DIP switch banks on the main controller board (SW1 and SW2), eight DIP switches for each bank. These DIP switches can be set on/off, using the tip of a tool, such as a small screwdriver.

The printer parameter such as printer density, baud rate, and auto-cutter enable/disable etc. can be set via these two DIP switches as follows.

i New DIP switch settings are enabled after the printer is turned on!

■ Serial Interface (RS-232C)

- DIP Switches 1

SW	Function	ON	OFF	Default
1-1	Auto Line Feed at CR	Enable	Disable	OFF
1-2	Handshaking	XON/XOFF	DTR/DSR	OFF
1-3	Data Length	7bits	8bits	OFF
1-4	Parity Check	Yes	No	OFF
1-5	Parity Selection	EVEN	ODD	OFF
1-6	Baud Rate Selection	Refer to the following table 1		OFF
1-7				ON
1-8	(bps)			OFF

Tally Dascom DT-210/230

- DIP Switches 2

SW	Function	ON	OFF	Default
2-1	Reserved	-	-	OFF
2-2	Internal bell control	Internal bell disable	Internal bell enable	OFF
2-3	Auto Cutter	Disable	Enable	OFF
2-4	BUSY Condition	Receive Buffer Full	Offline or Receive Buffer Full	OFF
2-5	Print Density	Refer to the following table 2		OFF
2-6				OFF
2-7				OFF
2-8	Near-End Sensor Status	Disable	Enable	OFF

■ Parallel and USB2.0 Interface

- DIP Switches 1

SW	Function	ON	OFF	Default
1-1	Auto Line Feed at CR	Enable	Disable	OFF
1-2	Reserved	-	-	OFF
~				
1-8				

- DIP Switches 2

SW	Function	ON	OFF	Default
2-1	Reserved	-	-	OFF
2-2	Internal bell control	Internal bell disable	Internal bell enable	OFF
2-3	Auto Cutter	Disable	Enable	OFF
2-4	BUSY Condition	Receive Buffer Full	Offline or Receive Buffer Enable	OFF
2-5	Print Density	Refer to the following Table 2		OFF
2-6				OFF
2-7				OFF
2-8	Near-End Sensor Status	Disable	Enable	OFF

Tally Dascom DT-210/230

- Table 1 – Baud rate (bps) Selection

Transmission Speed	1-6	1-7	1-8	Default
2400	ON	OFF	OFF	19200
4800	ON	OFF	ON	
9600	OFF	ON	OFF	
19200	OFF	OFF	OFF	
38400	OFF	ON	ON	
57600	OFF	OFF	ON	
115200	ON	ON	ON	

- Table 2 – Print Density Selection

2-5	2-6	2-7	Print Density (Mono color)	Default
ON	ON	Reserved	1(Light)	2
OFF	OFF	Reserved	2	
ON	OFF	Reserved	3	
OFF	ON	Reserved	4(Dark)	

- **Auto Cutter Enable / Disable selection**

Dip Switch Set 2		
SW 2-3	ON	Auto Cutter Disabled
	OFF	Auto Cutter Enabled
Application	Ignores Auto Cutter error for continuous printing.	

4 Troubleshooting

Your printer is extremely reliable, but occasionally problems may occur. This chapter provides information on some of the common problems you may encounter and how you may solve them. If you encounter problems that you can not resolve, contact your dealer for assistance.

Read the following instructions before maintenance and avoid incorrect operation, so as to prevent injury to you and damage to the printer.

4.1 Processing LED and printing error

■ LED indicator on the control panel and beeper alarm

Trouble	Potential Problem	Solution
No LEDs on	Incorrect power supply cable connections and power outlet	Check the power supply cable connections and the power outlet and correct them.
	PCB damaged	Contact your dealer for assistance.
Paper LED always on	Paper near end	The roll paper is near end, the printer can work normally, procure new paper.
Error LED always on and beeper alarms	Printer Cover open	Close the Printer Cover.
Power, Paper and Error LEDs always on and beeper alarms	Paper end	Reload the roll paper.
Error LED blinks and beeper alarms	Thermal Print Head overheated	Turn the printer off and wait some minutes before you resume.
	Overtoltage	Print with specified voltage.
	Low-voltage	Print with specified voltage, use original power adapter.

■ Troubles occur during printing

Trouble	Potential Problem	Solution
Coloured stripe in the paper	Paper near end	Install a new roll of paper.
Blurred or spot printing	Incorrect roll paper	Install the paper roll correctly.
	Poor paper quality	Use recommended thermal roll paper.
	Dirty thermal head or print rooler	Clean the thermal head or print rooler.
	Low Print density	Increase the print density level.
Paper Jam	Paper stuck	Open the printer cover, check the paper path and remove jammed paper.
Vertical dot line missing	Dirty thermal head or print	Clean the thermal head or print rooler.
	Thermal head damaged	Contact your dealer for assistance.

4.2 Removing jammed paper



Printhead may be hot, please do not touch!

- Turn the printer off and press the cover open button.
- Remove jammed paper, reinstall the roll, and close the cover.
- If paper is caught in the cutter and you cannot open the printer cover, open the cutter cover as shown on the left below.
- Turn the knob until the cutter blade returns to the normal position, as shown on the right picture below. There is a label to assist you.
- Close the cutter cover.
- Open the printer cover and remove the jammed paper.

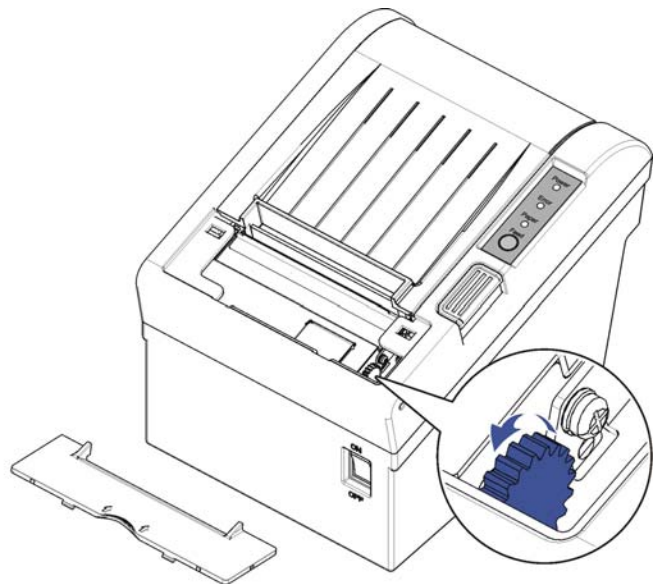
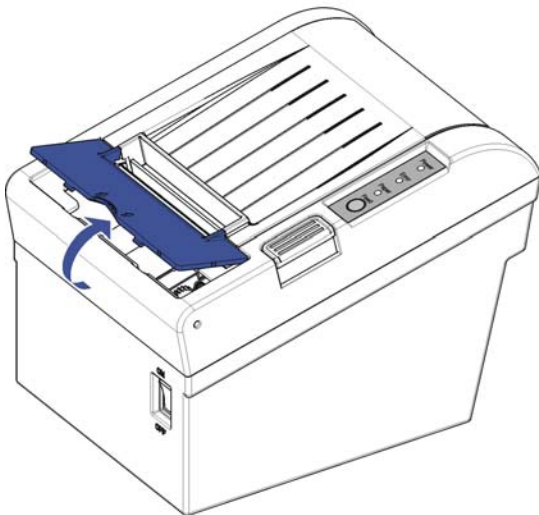

4.3 Cleaning thermal print head



After printing, the thermal print head becomes very hot. Be careful not to touch it and to let it cool before you clean it.

Do not damage the thermal print head by touching it with your fingers or any hard object.

- Turn off the printer, open the printer cover, and clean the thermal elements of the print head with a cotton swab moistened with an alcohol solvent (ethanol, methanol, or isopropyl).
- We recommend cleaning the thermal head periodically (generally every 3 months) to maintain receipt print quality.

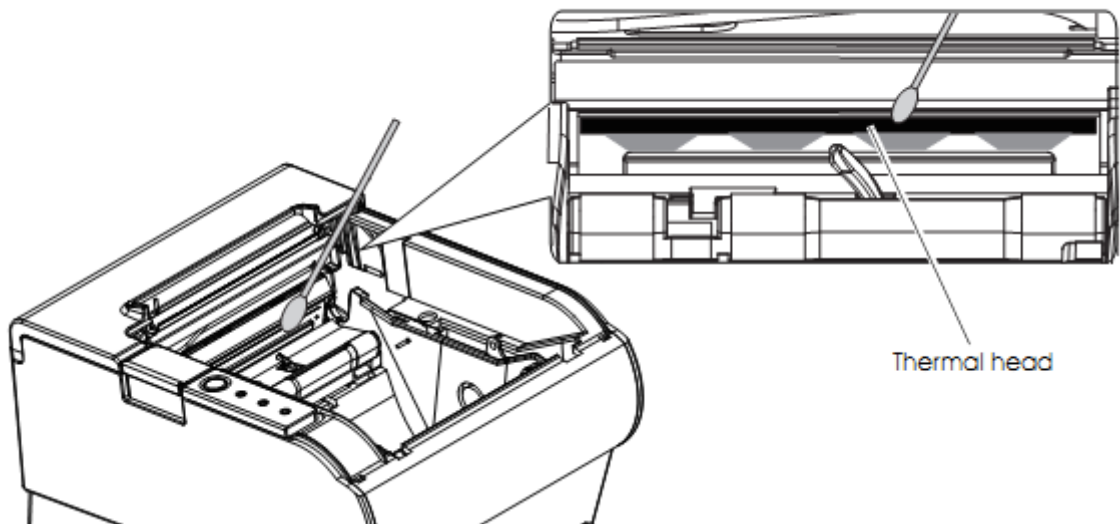

5 Specifications

5.1 Printer specification

Print Parameter	Print method	Direct thermal line printing
	Resolution	203DPI, 8dots/mm
	Print speed	DT-230: 260mm/s Default; 240-270mm/s adjustable via DIP. DT-210: 220mm/s Default; 210-230mm/s adjustable via DIP.
	Print width	72mm (576dots)
	Interface	USB (On-board) + Cash Drawer (On-board) + one optional interface (daughter board): Serial, Parallel, Ethernet, Wi-Fi or fiscal interface.
Print density	The density can be adjusted to different levels: DT-210: Level 1 Density light: Speed 230 m/s Level 2 Density middle: Speed 220 m/s Level 3 Density middle: Speed 210 m/s Level 4 Density dark: Speed 200 m/s DT-230: Level 1 Density light: Speed 270 m/s Level 2 Density middle: Speed 260 m/s Level 3 Density middle: Speed 250 m/s Level 4 Density dark: Speed 240 m/s	
Power consumption		51.6W(Normal) 7W(Standby)
Memory	RAM	1Mbytes
	Flash	4Mbytes
Receive buffer		48Kbytes
Fonts	Characters per line	Font A, Special Font A: 48 cpl Font B, Special Font B: 64 cpl
	User-defined	Supported
	Code page	12 code pages (PC437, PC850, PC852, PC858, PC860, PC863, PC865, PC866, KU42, TIS11, TIS18, PC720)
	Chinese Character	GB18030 24×24
Barcodes	1D	UPC-A, UPC-E, EAN8, EAN13, CODE39, ITF, CODEBAR, CODE128, CODE32
	2D	PDR417, QR code
Graphics		Supports several bitmap densities and download image printing. (Maximum size of each bitmap is 64kB. The total size of memory is 256K.)
Detect Function	Sensors	Paper End, Paper Near End, Paper Jam and Cover Open sensors.
Power Supply		External power adapter
	Input	AC 100V-240V 50-60Hz
	Output	DC 24V±5%, 2.15A, A-1009-3P interface

Tally Dascom DT-210/230

Paper Handling	Paper type	Standard Thermal Paper (see P31- 5.4 paper specification)
	Paper width	79.5±0.5mm/57.5±0.5mm
	Paper thickness	0.056~0.1mm
	Paper roll diameter	Max. OD ϕ 83mm Min. ID ϕ 13mm
	Paper load	Upward cover open and Easy paper loading
	Paper cut	Manual tear; Auto-cutter (hay cutter type) and partial cut.
Emulation		ESC/POS (TM-T88IV) Compatible command set
Noise		The noise level will be less than 50 dBA at 260mm/s printing speed (to be measured in accordance with ISO 7779)
Physical Spec.	Operating condition	5~45°C/10~95%RH
	Storage condition	-10~50°C/10~95%RH
	Dimensions	147×198×146 (W×L×H mm)
	Color	Black
	Weight	Approx. 1.8kg
Optional Kits		Splash cover and Hanging plate
Accessory		Interface cover
Reliability	Head lifetime	150km
	MTBF	360,000 hours
	Cutter lifetime	2,000,000 cuts
	MCBF	52,000,000 lines
Software	Driver	Windows, 32 & 64 Bit
Certification		CCC, CE, UL, FCC, Energy Star

5.2 Interfaces

Power Supply interface, USB interface and cash drawer interface are standard interfaces for the printer.

Serial interface, Parallel interface, Ethernet interface and Wi-Fi interface are optional interfaces for the printer.

The interface pin assignment is listed below.

5.2.1 USB interface

USB interface pin assignment

PIN No.	Description	Classic wire color
1	VBUS	Red
2	D-	White
3	D+	Green
4	GND	Black

USB interface connector diagram

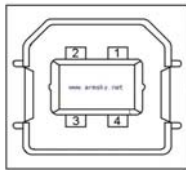

5.2.2 Cash Drawer interface

Cash Drawer interface pin assignment

Cash drawer interface supports DC24V, 1A, RJ-11 6P type socket.

Pin. No.	Description	Direction
1	Frame Ground	-
2	Drawer kick-out drive signal 1	Output
3	Drawer open/close signal	Input
4	+24V	-
5	Drawer kick-out drive signal 2	Output
6	GND	-

Cash Drawer interface connector diagram

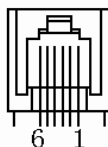

5.2.3 Serial interface

Serial interface pin assignment

Serial interface compatible with RS-232 standard, with 25 pin (D hole type) socket.

PIN No.	Description
PIN 1	Frame Ground
PIN 2	TXD
PIN 3	RXD
PIN 4	RTS
PIN 5	Unconnected
PIN 6	DSR
PIN 7	Signal Ground
PIN 8~19	Unconnected
PIN 20	DTR
PIN 21~25	Unconnected

- i** User can view the setting of interface via printing configuration sample.
The default setting of serial interface is as follow, 38400 bps (baud rates), 8 bit (data bit), 1 bit (stop bit), no parity, support RTS/CTS handshaking protocol.

Serial interface connector diagram

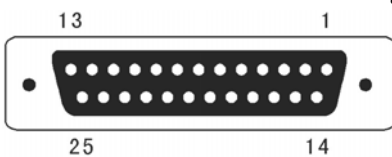

5.2.4 Parallel interface

Parallel interface pin assignment

Parallel interface with 36 pin CENTRONICS socket.

Pin No.	Signal From	Description
1	H	Strobe Signal; Data latch pulse, latch the data to the printer at the rising edge of the negative pulse.
2	H	Data 0 (The lowest bit)
3	H	Data 1
4	H	Data 2

Tally Dascom DT-210/230

5	H	Data 3
6	H	Data 4
7	H	Data 5
8	H	Data 6
9	H	Data 7 (The highest bit)
10	P	ACK Signal; Printer response signal, indicates that the printer has received a Data byte.
11	P	Busy Signal; The printer is busy; High level indicates that the printer can't receive data.
12	P	PE Signal; Paper end signal; High level indicates that the printer is out of paper.
13	—	Unconnected
14	—	Unconnected
15	—	Unconnected
16	Logic Ground	
17	Frame Ground, separated from logic ground.	
18	—	Unconnected
19~30	Logic Ground	
31	—	Unconnected
32	P	Printer error signal. Low level indicates that a error occurs in the printer. It will come with paper end.
33	Logic Ground	
34~35	—	Unconnected
36	Unconnected	

i H indicates that signal comes from Host computer; P indicates that signal comes from Printer.

Parallel interface connector diagram

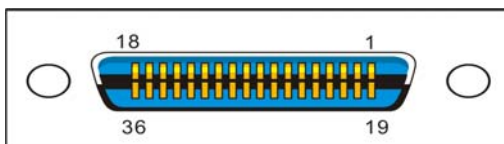

5.2.5 Ethernet interface

Ethernet interface pin assignment

Pin. No.	Name	Description
1	TX+	Tranceive Data+
2	TX-	Tranceive Data-
3	RX+	Receive Data+
4	n/c	Not connected
5	n/c	Not connected
6	RX-	Receive Data-
7	n/c	Not connected
8	n/c	Not connected

Ethernet interface connector diagram

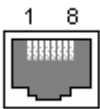

5.2.6 Wi-Fi interface

Wi-Fi interface supports 2.4 GHz, IEEE Std. 802.11b standard.

5.3 Power adapter

Power Socket pin assignment

Pin Number	Signal Name
1	+24 V
2	GND
3	N.C
SHELL	F.G.

Power Supply connector diagram

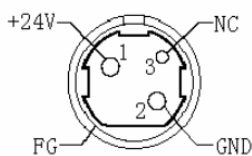

Power Supply interface type

Printer - Unetop DC-002 or similar products

Computer - Unetop DP-002 or similar products

5.4 Paper specification

Paper type	Specified thermal paper	
Form	Roll paper	
Size	Roll paper diameter	83 mm {3.27"} maximum
	Min. core diameter	13mm
	Take-up roll paper width	80 + 0.5/-1.0 mm
	Paper width	79.5 ± 0.5 mm
CAUTION		
<ul style="list-style-type: none"> • Paper must not be pasted to the roll paper spool. • The remaining amount of the roll paper when a roll paper near-end is detected differs depending on the spool type. 		

Printable Area

The printable area of a paper with width of 79.5 ± 0.5 mm {3.13 ± 0.02"} is 72.2 ± 0.2 mm {2.84 ± 0.008"} (576 dots) and the space on the right and left sides are approximately 3.7 ± 2 mm {0.15 ± 0.079"}.

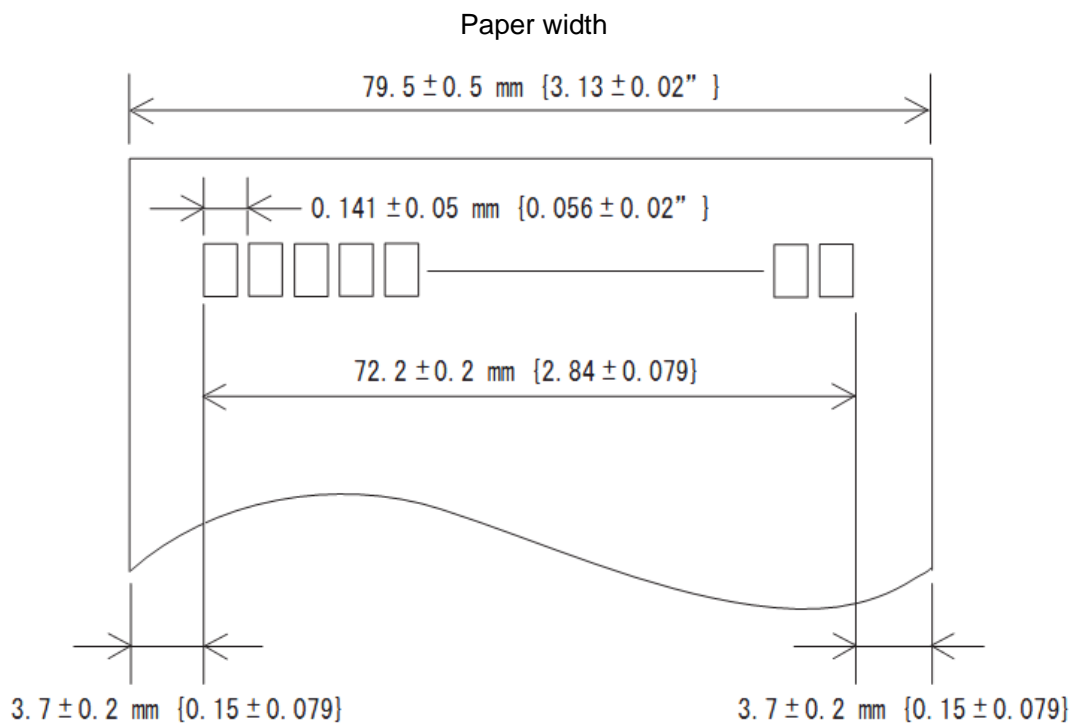

All the numeric values are typical.

Printing and Cutting Positions

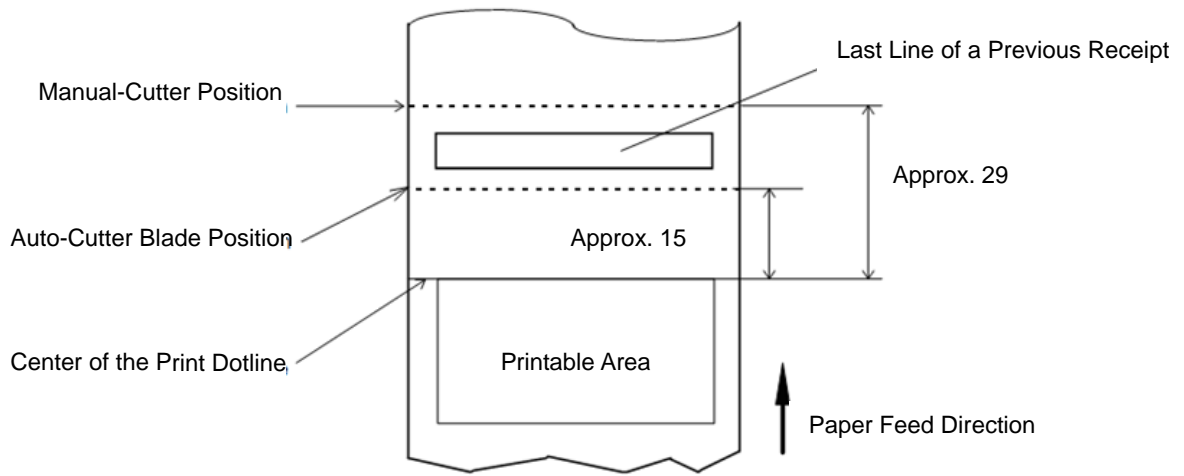

Unit: mm (All the numeric values are typical.)

6 Character Code Pages

■ Common to all pages (International Character Set: USA)

HEX	0	1	2	3	4	5	6	7
0	NUL 00	DLE 16	SP 32	0 48	@ 64	P 80	` 96	p 112
1		XON 17	! 33	1 49	A 65	Q 81	a 97	q 113
2			" 34	2 50	B 66	R 82	b 98	r 114
3		XOFF 19	# 35	3 51	C 67	S 83	c 99	s 115
4	EOT 04	DC4 20	\$ 36	4 52	D 68	T 84	d 100	t 116
5	ENQ 05	NAK 21	% 37	5 53	E 69	U 85	e 101	u 117
6	ACK 06		& 38	6 54	F 70	V 86	f 102	v 118
7			' 39	7 55	G 71	W 87	g 103	w 119
8		CAN 24	(40	8 56	H 72	X 88	h 104	x 120
9	HT 09) 41	9 57	I 73	Y 89	i 105	y 121
A	LF 10		* 42	: 58	J 74	Z 90	j 106	z 122
B		ESC 27	+ 43	; 59	K 75	[91	k 107	{ 123
C	FF 12	FS 28	, 44	< 60	L 76	\ 92	l 108	 124
D	CR 13	GS 29	- 45	= 61	M 77] 93	m 109	} 125
E		RS 30	. 46	> 62	N 78	^ 94	n 110	~ 126
F			/ 47	? 63	O 79	_ 95	o 111	SP 127

■ International Character Sets

Country	ASCII code (Hex)											
	23	24	40	5B	5C	5D	5E	60	7B	7C	7D	7E
USA	#	\$	@	[\]	^	`	{		}	~
France	#	\$	à	°	ç	§	^	`	é	ù	è	¨
Germany	#	\$	§	Ä	Ö	Ü	^	`	ä	ö	ü	ß
U.K.	£	\$	@	[\]	^	`	{		}	~
Denmark I	#	\$	@	Æ	Ø	À	^	`	æ	ø	à	~
Sweden	#	¤	É	Ä	Ö	À	Ü	é	ä	ö	å	ü
Italy	#	\$	@	°	\	é	^	ù	à	ò	è	ì
Spain I	Pt	\$	@	í	Ñ	¿	^	`	¨	ñ	}	~
Japan	#	\$	@	[¥]	^	`	{		}	~
Norway	#	¤	É	Æ	Ø	À	Ü	é	æ	ø	à	ü
Denmark II	#	\$	É	Æ	Ø	À	Ü	é	æ	ø	à	ü
Spain II	#	\$	á	í	Ñ	¿	é	`	í	ñ	ó	ú
Latin America	#	\$	á	í	Ñ	¿	é	ü	í	ñ	ó	ú
Korea	#	\$	@	[₩]	^	`	{		}	~
Slovenia/ Croatia	#	\$	Ž	Š	Đ	Ć	Č	ž	š	đ	ć	č
China	#	¥	@	[\]	^	`	{		}	~

■ [User-defined page]

HEX	8	9	A	B	C	D	E	F
0	SP 128	SP 144	SP 160	SP 176	SP 192	SP 208	SP 224	SP 240
1	SP 129	SP 145	SP 161	SP 177	SP 193	SP 209	SP 225	SP 241
2	SP 130	SP 146	SP 162	SP 178	SP 194	SP 210	SP 226	SP 242
3	SP 131	SP 147	SP 163	SP 179	SP 195	SP 211	SP 227	SP 243
4	SP 132	SP 148	SP 164	SP 180	SP 196	SP 212	SP 228	SP 244
5	SP 133	SP 149	SP 165	SP 181	SP 197	SP 213	SP 229	SP 245
6	SP 134	SP 150	SP 166	SP 182	SP 198	SP 214	SP 230	SP 246
7	SP 135	SP 151	SP 167	SP 183	SP 199	SP 215	SP 231	SP 247
8	SP 136	SP 152	SP 168	SP 184	SP 200	SP 216	SP 232	SP 248
9	SP 137	SP 153	SP 169	SP 185	SP 201	SP 217	SP 233	SP 249
A	SP 138	SP 154	SP 170	SP 186	SP 202	SP 218	SP 234	SP 250
B	SP 139	SP 155	SP 171	SP 187	SP 203	SP 219	SP 235	SP 251
C	SP 140	SP 156	SP 172	SP 188	SP 204	SP 220	SP 236	SP 252
D	SP 141	SP 157	SP 173	SP 189	SP 205	SP 221	SP 237	SP 253
E	SP 142	SP 158	SP 174	SP 190	SP 206	SP 222	SP 238	SP 254
F	SP 143	SP 159	SP 175	SP 191	SP 207	SP 223	SP 239	SP 255

■ [PC437: USA, Standard Europe]

HEX	8	9	A	B	C	D	E	F
0	Ç 128	É 144	á 160	☐ 176	L 192	⌌ 208	α 224	≡ 240
1	ü 129	æ 145	í 161	☐ 177	⌋ 193	⌑ 209	β 225	± 241
2	é 130	Æ 146	ó 162	☐ 178	⌒ 194	⌐ 210	Γ 226	≥ 242
3	â 131	ô 147	ú 163	 179	⌑ 195	⌌ 211	π 227	≤ 243
4	ä 132	ö 148	ñ 164	⌑ 180	— 196	⌌ 212	Σ 228	∫ 244
5	à 133	ò 149	Ñ 165	⌑ 181	⌑ 197	ƒ 213	σ 229	∫ 245
6	ã 134	û 150	ª 166	⌑ 182	ƒ 198	π 214	μ 230	÷ 246
7	ç 135	ù 151	º 167	π 183	⌑ 199	⌑ 215	τ 231	≈ 247
8	ê 136	ÿ 152	¿ 168	⌑ 184	⌌ 200	⌑ 216	Φ 232	° 248
9	ë 137	Ö 153	Γ 169	⌑ 185	ƒ 201	∫ 217	Θ 233	• 249
A	è 138	Ü 154	ˆ 170	⌌ 186	⌌ 202	Γ 218	Ω 234	˙ 250
B	ï 139	ø 155	½ 171	⌑ 187	⌑ 203	■ 219	δ 235	√ 251
C	î 140	£ 156	¼ 172	⌑ 188	⌑ 204	■ 220	∞ 236	ⁿ 252
D	ì 141	¥ 157	¡ 173	⌑ 189	= 205	■ 221	Φ 237	² 253
E	Ä 142	Pt 158	« 174	⌑ 190	⌑ 206	■ 222	ε 238	■ 254
F	Å 143	f 159	» 175	⌑ 191	⌑ 207	■ 223	∩ 239	SP 255

■ [PC850: Multilingual]

HEX	8	9	A	B	C	D	E	F
0	Ç 128	É 144	á 160	☐ 176	L 192	ø 208	Ó 224	- 240
1	ü 129	æ 145	í 161	☐ 177	Ł 193	Ð 209	β 225	± 241
2	é 130	Æ 146	ó 162	☐ 178	Т 194	Ê 210	Ô 226	= 242
3	â 131	ô 147	ú 163	 179	† 195	Ë 211	Ò 227	¾ 243
4	ä 132	ö 148	ñ 164	‡ 180	- 196	È 212	õ 228	¶ 244
5	à 133	ò 149	Ñ 165	Á 181	† 197	ı 213	Õ 229	§ 245
6	â 134	û 150	ä 166	Â 182	ã 198	Í 214	μ 230	÷ 246
7	ç 135	ù 151	å 167	À 183	Ã 199	Î 215	þ 231	· 247
8	ê 136	ÿ 152	ı 168	© 184	Ł 200	Ï 216	ƒ 232	° 248
9	ë 137	Ö 153	® 169	¶ 185	ƒ 201	Ј 217	Ú 233	“ 249
A	è 138	Ü 154	¬ 170	 186	Ł 202	Г 218	Û 234	· 250
B	ÿ 139	ø 155	½ 171	¶ 187	π 203	■ 219	Ù 235	¹ 251
C	î 140	£ 156	¼ 172	¶ 188	ƒ 204	■ 220	ý 236	³ 252
D	ì 141	Ø 157	ı 173	¢ 189	= 205	ı 221	Ý 237	² 253
E	Ä 142	× 158	« 174	¥ 190	¶ 206	İ 222	- 238	■ 254
F	Å 143	f 159	» 175	‡ 191	□ 207	■ 223	' 239	SP 255



■ [PC852: Latin2]

HEX	8	9	A	B	C	D	E	F
0	Ç 128	É 144	á 160	☐ 176	L 192	đ 208	Ó 224	- 240
1	ü 129	Í 145	í 161	☐ 177	⊥ 193	Đ 209	β 225	“ 241
2	é 130	Í 146	ó 162	☐ 178	⊥ 194	Đ 210	Ô 226	˘ 242
3	â 131	ô 147	ú 163	 179	† 195	Ë 211	Ń 227	˘ 243
4	ä 132	ö 148	Ą 164	† 180	- 196	ď 212	ń 228	˘ 244
5	û 133	Ĺ 149	ą 165	Á 181	† 197	Ň 213	ň 229	§ 245
6	ć 134	İ 150	Ż 166	Â 182	Ă 198	Í 214	Š 230	+ 246
7	ç 135	Ś 151	ż 167	Ě 183	ă 199	Î 215	š 231	˘ 247
8	ł 136	ś 152	Ę 168	Ş 184	Ł 200	ě 216	Ŕ 232	° 248
9	ë 137	Ö 153	ę 169	ǂ 185	Ŧ 201	Ј 217	Ú 233	“ 249
A	Ö 138	Ü 154	SP 170	ǂ 186	⊥ 202	Г 218	ř 234	• 250
B	ö 139	Ť 155	ž 171	ǂ 187	ǂ 203	■ 219	Ů 235	ů 251
C	î 140	ť 156	Č 172	ǂ 188	ǂ 204	■ 220	ý 236	Ř 252
D	Ž 141	ł 157	ş 173	Ž 189	= 205	Ŧ 221	Ý 237	ř 253
E	Ă 142	× 158	« 174	ž 190	ǂ 206	Ů 222	ţ 238	■ 254
F	Ć 143	č 159	» 175	Ŧ 191	α 207	■ 223	' 239	SP 255

■ [PC858: Euro]

HEX	8	9	A	B	C	D	E	F
0	Ç 128	É 144	á 160	☐ 176	Ł 192	ð 208	Ó 224	- 240
1	ü 129	æ 145	í 161	☐ 177	Ł 193	Ð 209	β 225	± 241
2	é 130	Æ 146	ó 162	☐ 178	Ƨ 194	Ê 210	Ô 226	= 242
3	â 131	ô 147	ú 163	 179	Ƨ 195	Ë 211	Ò 227	¾ 243
4	ä 132	ö 148	ñ 164	† 180	- 196	È 212	õ 228	¶ 244
5	à 133	ò 149	Ñ 165	Á 181	† 197	€ 213	Ö 229	§ 245
6	â 134	û 150	à 166	Â 182	ã 198	Í 214	μ 230	÷ 246
7	ç 135	ù 151	á 167	À 183	Ã 199	Î 215	þ 231	· 247
8	ê 136	ÿ 152	ç 168	© 184	ℒ 200	Ï 216	þ 232	° 248
9	ë 137	Ö 153	® 169	¶ 185	Ʀ 201	Ɔ 217	Ú 233	¨ 249
A	è 138	Ü 154	¬ 170	 186	Ł 202	Ɠ 218	Û 234	· 250
B	ï 139	ø 155	½ 171	¶ 187	Ƨ 203	■ 219	Ü 235	¹ 251
C	î 140	£ 156	¼ 172	¶ 188	Ƨ 204	■ 220	Ý 236	³ 252
D	ì 141	Ø 157	ì 173	¢ 189	= 205	ì 221	Ý 237	² 253
E	Ä 142	× 158	« 174	¥ 190	¶ 206	î 222	- 238	■ 254
F	Å 143	f 159	» 175	Ƨ 191	¤ 207	■ 223	' 239	SP 255

■ [PC860: Portuguese]

HEX	8	9	A	B	C	D	E	F
0	Ç 128	É 144	á 160	 176	Ł 192	⋈ 208	α 224	≡ 240
1	ü 129	À 145	í 161	 177	Ł 193	⋈ 209	β 225	± 241
2	é 130	È 146	ó 162	 178	⋈ 194	⋈ 210	Γ 226	≥ 242
3	â 131	ô 147	ú 163	 179	⋈ 195	⋈ 211	π 227	≤ 243
4	ã 132	õ 148	ñ 164	⋈ 180	— 196	⋈ 212	Σ 228	 244
5	à 133	ò 149	Ñ 165	⋈ 181	⋈ 197	⋈ 213	σ 229	 245
6	Á 134	Ú 150	ª 166	⋈ 182	⋈ 198	⋈ 214	μ 230	÷ 246
7	ç 135	ù 151	º 167	⋈ 183	⋈ 199	⋈ 215	τ 231	≈ 247
8	ê 136	î 152	¿ 168	⋈ 184	⋈ 200	⋈ 216	Φ 232	° 248
9	Ê 137	Ï 153	Ò 169	⋈ 185	⋈ 201	⋈ 217	Θ 233	• 249
A	è 138	Ü 154	¬ 170	⋈ 186	⋈ 202	⋈ 218	Ω 234	· 250
B	Í 139	ç 155	½ 171	⋈ 187	⋈ 203	■ 219	δ 235	√ 251
C	Ó 140	£ 156	¼ 172	⋈ 188	⋈ 204	■ 220	∞ 236	ⁿ 252
D	ì 141	Ù 157	¡ 173	⋈ 189	= 205	■ 221	Φ 237	² 253
E	Ã 142	Pt 158	« 174	⋈ 190	⋈ 206	■ 222	ε 238	■ 254
F	Â 143	Ó 159	» 175	⋈ 191	⋈ 207	■ 223	∩ 239	SP 255









■ [PC863: Canadian-French]

HEX	8	9	A	B	C	D	E	F
0	Ç 128	É 144	Ï 160	⌘ 176	Ł 192	⌚ 208	α 224	≡ 240
1	Û 129	È 145	´ 161	⌘ 177	⌚ 193	⌚ 209	β 225	± 241
2	é 130	Ê 146	ó 162	⌘ 178	⌚ 194	⌚ 210	Γ 226	≥ 242
3	â 131	ô 147	ú 163	 179	† 195	⌚ 211	π 227	≤ 243
4	Â 132	Ë 148	¨ 164	† 180	– 196	⌚ 212	Σ 228	∫ 244
5	à 133	Ï 149	˙ 165	† 181	† 197	ƒ 213	σ 229	∫ 245
6	¶ 134	û 150	³ 166	¶ 182	† 198	π 214	μ 230	÷ 246
7	ç 135	ù 151	– 167	π 183	† 199	¶ 215	τ 231	≈ 247
8	ê 136	⌘ 152	î 168	† 184	⌚ 200	† 216	Φ 232	° 248
9	ë 137	Ô 153	ƒ 169	¶ 185	ƒ 201	∫ 217	Θ 233	• 249
A	è 138	Û 154	˘ 170	¶ 186	⌚ 202	ƒ 218	Ω 234	˙ 250
B	ï 139	ç 155	½ 171	¶ 187	⌚ 203	■ 219	δ 235	√ 251
C	î 140	£ 156	¼ 172	¶ 188	† 204	■ 220	∞ 236	ⁿ 252
D	= 141	Û 157	¾ 173	¶ 189	= 205	■ 221	Φ 237	² 253
E	À 142	Ô 158	« 174	† 190	⌚ 206	■ 222	ε 238	■ 254
F	§ 143	f 159	» 175	† 191	± 207	■ 223	∩ 239	SP 255

■ [PC865: Nordic]

HEX	8	9	A	B	C	D	E	F
0	Ç 128	É 144	á 160	☐ 176	L 192	⌌ 208	α 224	≡ 240
1	ü 129	æ 145	í 161	☐ 177	⌌ 193	⌌ 209	β 225	± 241
2	é 130	Æ 146	ó 162	☐ 178	⌌ 194	⌌ 210	Γ 226	≥ 242
3	â 131	ô 147	ú 163	 179	⌌ 195	⌌ 211	π 227	≤ 243
4	ä 132	ö 148	ñ 164	⌌ 180	- 196	⌌ 212	Σ 228	 244
5	à 133	ò 149	Ñ 165	⌌ 181	⌌ 197	F 213	σ 229	 245
6	â 134	û 150	ä 166	⌌ 182	⌌ 198	⌌ 214	μ 230	÷ 246
7	ç 135	ù 151	º 167	⌌ 183	⌌ 199	⌌ 215	τ 231	≈ 247
8	ê 136	ÿ 152	¿ 168	⌌ 184	⌌ 200	⌌ 216	Φ 232	° 248
9	ë 137	Ö 153	ƒ 169	⌌ 185	⌌ 201	⌌ 217	Θ 233	• 249
A	è 138	Ü 154	ƒ 170	⌌ 186	⌌ 202	⌌ 218	Ω 234	• 250
B	ï 139	ø 155	½ 171	⌌ 187	⌌ 203	⌌ 219	δ 235	√ 251
C	î 140	£ 156	¼ 172	⌌ 188	⌌ 204	⌌ 220	∞ 236	n 252
D	ì 141	Ø 157	í 173	⌌ 189	= 205	⌌ 221	Φ 237	² 253
E	Ä 142	Pt 158	« 174	⌌ 190	⌌ 206	⌌ 222	ε 238	■ 254
F	Å 143	f 159	▣ 175	⌌ 191	⌌ 207	⌌ 223	∩ 239	SP 255

■ [PC866: Cyrillic #2]

HEX	8	9	A	B	C	D	E	F
0	А 128	Р 144	а 160	 176	Л 192	л 208	р 224	Ё 240
1	Б 129	С 145	б 161	 177	Л 193	т 209	с 225	ё 241
2	В 130	Т 146	в 162	 178	Т 194	П 210	т 226	Є 242
3	Г 131	У 147	г 163	 179	т 195	л 211	у 227	є 243
4	Д 132	Ф 148	д 164	† 180	— 196	Е 212	ф 228	Ї 244
5	Е 133	Х 149	е 165	† 181	† 197	Г 213	х 229	ї 245
6	Ж 134	Ц 150	ж 166	 182	Г 198	Г 214	ц 230	Ў 246
7	З 135	Ч 151	з 167	П 183	 199	 215	ч 231	ў 247
8	И 136	Ш 152	и 168	Г 184	л 200	† 216	ш 232	° 248
9	Й 137	Щ 153	й 169	 185	Г 201	Г 217	щ 233	• 249
A	К 138	Ъ 154	к 170	 186	л 202	Г 218	ъ 234	· 250
B	Л 139	Ы 155	л 171	Г 187	т 203	 219	ы 235	√ 251
C	М 140	Ь 156	м 172	л 188	Г 204	 220	ь 236	№ 252
D	Н 141	Э 157	н 173	л 189	= 205	 221	э 237	¤ 253
E	О 142	Ю 158	о 174	Г 190	л 206	 222	ю 238	■ 254
F	П 143	Я 159	п 175	Г 191	л 207	 223	я 239	SP 255

■ [KU42: Thai]

HEX	8	9	A	B	C	D	E	F
0	┌ 128	○ 144	SP 160	ฅ 176	ย 192	ไ 208	' 224	๕ 240
1	┐ 129	๑ 145	ก 161	ฆ 177	ร 193	แ 209	˘ 225	๖ 241
2	└ 130	๒ 146	ข 162	ค 178	ฤ 194	โ 210	˙ 226	๗ 242
3	┘ 131	๓ 147	ค 163	ด 179	ล 195	ใ 211	˚ 227	๘ 243
4	┌ 132	๔ 148	ช 164	ฅ 180	ว 196	ไ 212	˛ 228	๙ 244
5	┐ 133	๕ 149	ง 165	ท 181	ศ 197	ฯ 213	˜ 229	๑๐ 245
6	└ 134	๖ 150	จ 166	ธ 182	ษ 198	ฯ 214	˝ 230	๑๑ 246
7	┘ 135	๗ 151	ฉ 167	น 183	ส 199	' 215	˞ 231	๑๒ 247
8	┌ 136	๘ 152	ช 168	บ 184	ท 200	๖ 216	˟ 232	๑๓ 248
9	┐ 137	๙ 153	ซ 169	ป 185	ฬ 201	๖ 217	ˠ 233	๑๔ 249
A	└ 138	๑๐ 154	ฅ 170	ผ 186	อ 202	๖ 218	ˡ 234	๑๕ 250
B	┘ 139	๑๑ 155	ญ 171	ฝ 187	ฮ 203	๖ 219	ˢ 235	๑๖ 251
C	← 140	๑๒ 156	ฎ 172	พ 188	ะ 204	๖ 220	ˣ 236	๑๗ 252
D	↑ 141	๑๓ 157	ฏ 173	ฟ 189	ภ 205	๖ 221	ˤ 237	๑๘ 253
E	→ 142	๑๔ 158	ฐ 174	ภ 190	า 206	˙ 222	๖ 238	๑๙ 254
F	↓ 143	๑๕ 159	ฑ 175	ม 191	า 207	๖ 223	๖ 239	SP 255

■ [TIS11: Thai]

HEX	8	9	A	B	C	D	E	F
0	๐ 128	๑ 144	๒ 160	๓ 176	๔ 192	๕ 208	๖ 224	๗ 240
1	๘ 129	๙ 145	๐ 161	๑ 177	๒ 193	๓ 209	๔ 225	๕ 241
2	๖ 130	๗ 146	๘ 162	๙ 178	๐ 194	๑ 210	๒ 226	๓ 242
3	๗ 131	๘ 147	๙ 163	๐ 179	๑ 195	๒ 211	๓ 227	๔ 243
4	๘ 132	๙ 148	๐ 164	๑ 180	๒ 196	๓ 212	๔ 228	๕ 244
5	๙ 133	๐ 149	๑ 165	๒ 181	๓ 197	๔ 213	๕ 229	๖ 245
6	๐ 134	๑ 150	๒ 166	๓ 182	๔ 198	๕ 214	๖ 230	๗ 246
7	๑ 135	๒ 151	๓ 167	๔ 183	๕ 199	๖ 215	๗ 231	๘ 247
8	๒ 136	๓ 152	๔ 168	๕ 184	๖ 200	๗ 216	๘ 232	๙ 248
9	๓ 137	๔ 153	๕ 169	๖ 185	๗ 201	๘ 217	๙ 233	๐ 249
A	๔ 138	๕ 154	๖ 170	๗ 186	๘ 202	๙ 218	๐ 234	๑ 250
B	๕ 139	๖ 155	๗ 171	๘ 187	๙ 203	๐ 219	๑ 235	๒ 251
C	๖ 140	๗ 156	๘ 172	๙ 188	๐ 204	๑ 220	๒ 236	๓ 252
D	๗ 141	๘ 157	๙ 173	๐ 189	๑ 205	๒ 221	๓ 237	๔ 253
E	๘ 142	๙ 158	๐ 174	๑ 190	๒ 206	๓ 222	๔ 238	๕ 254
F	๙ 143	๐ 159	๑ 175	๒ 191	๓ 207	๔ 223	๕ 239	๖ 255

■ [TIS18: Thai]

HEX	8	9	A	B	C	D	E	F
0	┌ 128	┐ 144	SP 160	ฐ 176	ภ 192	ะ 208	เ 224	อ 240
1	└ 129	┑ 145	ก 161	ฑ 177	ม 193	ั 209	แ 225	ด 241
2	┌ 130	๖ 146	ข 162	ฒ 178	ย 194	า 210	โ 226	ต 242
3	└ 131	๗ 147	ช 163	ณ 179	ร 195	ำ 211	ใ 227	ถ 243
4	 132	๘ 148	ค 164	ด 180	ถ 196	า 212	ไ 228	ฒ 244
5	— 133	๙ 149	ค 165	ด 181	ล 197	า 213	า 229	ฒ 245
6	└ 134	๐ 150	ฆ 166	ถ 182	ภ 198	า 214	า 230	บ 246
7	└ 135	๑ 151	ง 167	ท 183	ว 199	า 215	า 231	บ 247
8	└ 136	๒ 152	จ 168	ธ 184	ศ 200	า 216	า 232	บ 248
9	T 137	๓ 153	ฉ 169	น 185	ษ 201	า 217	า 233	บ 249
A	└ 138	๔ 154	ช 170	บ 186	ส 202	า 218	า 234	บ 250
B	█ 139	๕ 155	ช 171	ป 187	ท 203	า 219	า 235	บ 251
C	← 140	๖ 156	ณ 172	ผ 188	ฬ 204	า 220	า 236	บ 252
D	↑ 141	๗ 157	ญ 173	ฝ 189	อ 205	า 221	า 237	บ 253
E	→ 142	๘ 158	ภ 174	พ 190	ฮ 206	า 222	า 238	บ 254
F	↓ 143	๙ 159	ภ 175	ฟ 191	า 207	฿ 223	อ 239	SP 255

■ [PC720: Arabic]

HEX	8	9	A	B	C	D	E	F
0	SP 128	SP 144	ب 160	◻ 176	ل 192	ﻻ 208	ض 224	≡ 240
1	SP 129	◻ 145	ة 161	◻ 177	ﻻ 193	ﻻ 209	ط 225	◻ 241
2	é 130	◻ 146	ت 162	◻ 178	ﻻ 194	ﻻ 210	ظ 226	◻ 242
3	â 131	ô 147	ث 163	 179	ﻻ 195	ﻻ 211	ع 227	◻ 243
4	SP 132	◻ 148	ج 164	ﻻ 180	- 196	ﻻ 212	غ 228	◻ 244
5	à 133	- 149	ح 165	ﻻ 181	ﻻ 197	ﻻ 213	ف 229	◻ 245
6	SP 134	û 150	خ 166	ﻻ 182	ﻻ 198	ﻻ 214	ﻻ 230	◻ 246
7	ç 135	ù 151	د 167	ﻻ 183	ﻻ 199	ﻻ 215	ق 231	≈ 247
8	ê 136	ء 152	ذ 168	ﻻ 184	ﻻ 200	ﻻ 216	ك 232	◻ 248
9	ë 137	أ 153	ر 169	ﻻ 185	ﻻ 201	ﻻ 217	ل 233	◻ 249
A	è 138	أ 154	ز 170	ﻻ 186	ﻻ 202	ﻻ 218	م 234	◻ 250
B	ï 139	ؤ 155	س 171	ﻻ 187	ﻻ 203	◻ 219	ن 235	√ 251
C	î 140	£ 156	ش 172	ﻻ 188	ﻻ 204	◻ 220	ه 236	n 252
D	SP 141	إ 157	ص 173	ﻻ 189	= 205	◻ 221	و 237	² 253
E	SP 142	ئ 158	« 174	ﻻ 190	ﻻ 206	◻ 222	ى 238	◻ 254
F	SP 143	ا 159	» 175	ﻻ 191	ﻻ 207	◻ 223	ي 239	SP 255

7 Printing Control Command Sets

- Be compatible with ESC/POS command set
- Support NV image and page mode printing

List of Commands

Command	Name
HT	Horizontal tab
LF	Print and line feed
FF	Print and return to standard mode (in page mode)
CR	Print and carriage return
CAN	Cancel print data in page mode
DLE EOT	Transmit real-time status
DLE ENQ	Send real-time request to printer
DLE DC4	Generate pulse in real-time ($fn = 1$)
	Execute power-off sequence ($fn = 2$)
	Clear buffer(s) ($fn = 8$)
ESC FF	Print data in page mode
ESC SP	Set right-side character spacing
ESC !	Select print mode(s)
ESC \$	Set absolute print position
ESC %	Select/cancel user-defined character set
ESC &	Define user-defined characters
ESC ?	Select bit-image mode
ESC -	Turn underline mode on/off
ESC 2	Select default line spacing
ESC 3	Set line spacing
ESC =	Select peripheral device
ESC ?	Cancel user-defined characters
ESC @	Initialize printer
ESC D	Set horizontal tab positions
ESC E	Turn emphasized mode on/off
ESC G	Turn double-strike mode on/off
ESC J	Print and feed paper
ESC L	Select page mode
ESC M	Select character font
ESC R	Select an international character set
ESC S	Select standard mode
ESC T	Select print direction in page mode
ESC V	Turn 90 degrees clockwise rotation mode on/off
ESC W	Set print area in page mode
ESC \	Set relative print position

Command	Name
ESC a	Select justification
ESC c 3	Select paper sensor(s) to output paper-end signals
ESC c 4	Select paper sensor(s) to stop printing
ESC c 5	Enable/disable panel buttons
ESC d	Print and feed <i>n</i> lines
ESC p	Generate pulse
ESC t	Select character code table
ESC {	Turn upside-down print mode on/off
FS g 1	Write to NV user memory
FS g 2	Read from NV user memory
GS !	Select character size
GS \$	Set absolute vertical print position in page mode
GS (A	Execute test print
GS (D	Enable/disable real-time command
GS (E	Set user setup commands
	<Function 1> Change into the user setting mode.
	<Function 2> End the user setting mode session.
	<Function 5> Set the customized setting values.
	<Function 6> Transmit the customized setting values.
	<Function 11> Set the configuration item for the serial interface.
GS (H	Request transmission of response or status
	<Function 48> Set the process ID response.
GS (K	Select print control method(s)
	<Function 50> Select the print speed.
GS (L / GS 8 L	Set graphics data
	<Function 48> Transmit the NV graphics memory capacity.
	<Function 50> Print the graphics data in the print buffer.
	<Function 51> Transmit the remaining capacity of the NV graphics memory.
	<Function 64> Transmit the key code list for defined NV graphics.
	<Function 65> Delete all NV graphics data.
	<Function 66> Delete the specified NV graphics data.
	<Function 67> Define the NV graphics data (raster format).
<Function 69> Print the specified NV graphics data.	
<Function 112> Store the graphics data in the print buffer (raster format).	

Command	Name
	Set up and print symbol
GS (k	<p><Function 065> PDF417: Set the number of columns in the data region.</p> <p><Function 066> PDF417: Set the number of rows.</p> <p><Function 067> PDF417: Set the width of the module.</p> <p><Function 068> PDF417: Set the row height.</p> <p><Function 069> PDF417: Set the error correction level.</p> <p><Function 070> PDF417: Select the options.</p> <p><Function 080> PDF417: Store the data in the symbol storage area.</p> <p><Function 081> PDF417: Print the symbol data in the symbol storage area.</p> <p><Function 082> PDF417: Transmit the size information of the symbol data in the symbol storage area.</p> <p><Function 167> QR Code: Set the size of module.</p> <p><Function 169> QR Code: Select the error correction level.</p> <p><Function 180> QR Code: Store the data in the symbol storage area.</p> <p><Function 181> QR Code: Print the symbol data in the symbol storage area. <Function 182> QR Code: Transmit the size information of the symbol data in</p>
GS ?	Define downloaded bit image
GS /	Print downloaded bit image
GS :	Start/end macro definition
GS B	Turn white/black reverse print mode on/off
GS H	Select print position of HRI characters
GS I	Transmit printer ID
GS L	Set left margin
GS P	Set horizontal and vertical motion units
GS V	Select cut mode and cut paper
GS W	Set print area width
GS \	Set relative vertical print position in page mode
GS ^	Execute macro
GS a	Enable/disable Automatic Status Back (ASB)
GS f	Select font for HRI characters
GS g 0	Initialize maintenance counter
GS g 2	Transmit maintenance counter
GS h	Set bar code height
GS k	Print bar code
GS r	Transmit status
GS w	Set bar code width
FS p	Print NV bit image
FS q	Define NV bit image
GS v 0	Print raster bit image

The commands listed below in the first column are defined as “obsolete commands” in the ESC/POS command system.

This printer supports both upward-compatible commands and obsolete commands. However, the upward-compatible commands are recommended to use.

Obsolete command		Upward-compatible command
ESC i	Partial cut (one point left uncut)	GS V
ESC m	Partial cut (three points left uncut)	GS V
ESC u	Transmit peripheral device status	GS r
ESC v	Transmit paper sensor status	GS r
FS p	Print NV bit image	GS (L <Function 69>
FS q	Define NV bit image	GS (L <Function 67>
GS v 0	Print raster bit image	GS (L <Function 112 + 50>



“Obsolete commands” are commands that are supported by legacy models; however it is recommended to replace them with upward-compatible commands, because they will not be supported in the future products.

FCC STATEMENT

1. This device complies with Part 15 of the FCC Rules. Operation is subject to the following two conditions:

- a) This device may not cause harmful interference.
- b) This device must accept any interference received, including interference that may cause undesired operation.

2. Changes or modifications not expressly approved by the party responsible for compliance could void the user's authority to operate the equipment.



This equipment has been tested and found to comply with the limits for a Class B digital device, pursuant to Part 15 of the FCC Rules. These limits are designed to provide reasonable protection against harmful interference in a residential installation.

This equipment generates uses and can radiate radio frequency energy and, if not installed and used in accordance with the instructions, may cause harmful interference to radio communications. However, there is no guarantee that interference will not occur in a particular installation. If this equipment does cause harmful interference to radio or television reception, which can be determined by turning the equipment off and on, the user is encouraged to try to correct the interference by one or more of the following measures:

- Re-orientate or relocate the receiving antenna.
- Increase the separation between the equipment and receiver.
- Connect the equipment into an outlet on a circuit different from that to which the receiver is connected.
- Consult the dealer or an experienced radio/TV technician for help.

DASCOM REPRESENTATIVES

GERMANY

DASCOM Europe GmbH
Heuweg 3
D-89079 Ulm
Deutschland
Tel.: +49 (0) 731 2075 0
Fax: +49 (0) 731 2075 100
www.dascom.com

SINGAPORE (ASIA PACIFIC)

DASCOM AP Pte Ltd
21 Bukit Batok Crescent
#29-81, WCEGA Tower
Singapore 658065
Phone: +65 6760 8833
Fax: +65 6760 1066
www.dascom.com

AMERICAS

DASCOM Americas Corporation
421 W. Main Street,
Waynesboro, VA 22980
USA
Phone: +1 (877) 434 13 77
www.dascom.com

UNITED KINGDOM

DASCOM GB Ltd
Hart House, Priestley Road
Basingstoke, Hampshire
RG24 9PU, England
Phone: +44 (0) 1256 481481
Fax: +44 (0) 1256 481400
www.dascom.com

FRANCE

DASCOM Europe GmbH
117 Avenue Victor Hugo
92100 Boulogne-Billancourt
France
Phone: +33 (1) 73 02 51 98
www.dascom.com

CHINA

JIANGMEN DASCOM COMPUTER
PERIPHERALS CO., LTD
No. 399, Jinxing Road, Jianghai District,
Jiangmen, Guangdong P.R. China
www.dascom.com

“All rights reserved. Translations, reprinting or copying by any means of this manual complete or in part or in any different form requires our explicit approval. We reserve the right to make changes to this manual without notice. All care has been taken to ensure accuracy of information contained in this manual. However, we cannot accept responsibility for any errors or damages resulting from errors or inaccuracies of information herein.”